

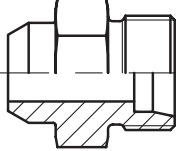

 Ermeto Original
Schweißverschraubungen

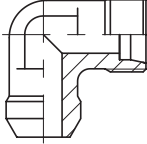
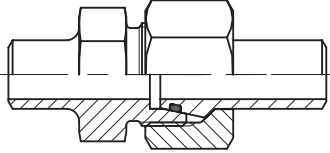
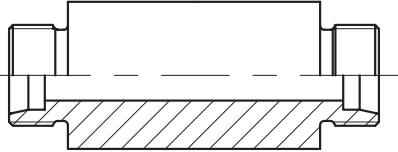
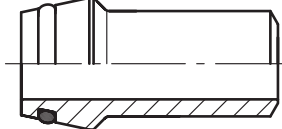
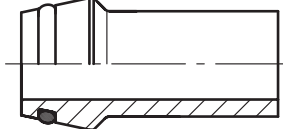
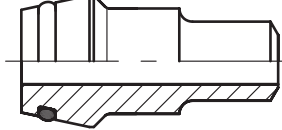

Index

<p>Anschweißverschraubungen</p>	 <p>AS S. L3</p>	 <p>WAS S. L4</p>
<p>Anschweißverschraubungen für Rohr</p>	 <p>ASK S. L5</p>	
<p>Einschweiß-Schottverschraubungen</p>	 <p>ESV S. L6</p>	
<p>Schweißkegel</p>	 <p>SKA S. L7</p>	 <p>SKA-ORB S. L10</p>
<p>Schweißkegel-Reduzierungen</p>	 <p>SKAR S. L8/9</p>	
<p>Schweißkegel-Rohrbogen</p>	 <p>SKA-RB S. L11</p>	
<p>O-Ring</p>	 <p>O-Ring S. L12</p>	

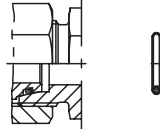
AS Anschweißstutzen

Anschweiß-Anschluss / EO 24° Anschluss

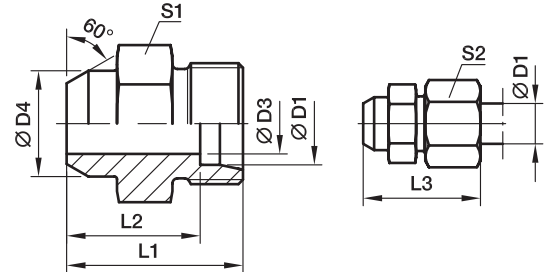

Bau- reihe	D1 	D3	D4	L1	L2	L3	S1	S2	Gewicht g/1 St.	Bestellzeichen	PN (bar) ¹⁾	
											Stahl	Edelstahl
L ³⁾	06	4	10	21	14,0	29	12	14	11	AS06L	315	315
	08	6	12	23	16,0	31	14	17	15	AS08L	315	315
	10	8	14	25	18,0	33	17	19	22	AS10L	315	315
	12	10	16	25	18,0	33	19	22	25	AS12L	315	315
	15	12	19	29	22,0	37	22	27	44	AS15L	315	315
	18	15	22	31	23,5	40	27	32	67	AS18L	315	315
	22	19	27	36	28,5	45	32	36	98	AS22L	160	160
	28	24	32	38	30,5	47	41	41	165	AS28L	160	160
	35	30	40	43	32,5	54	46	50	232	AS35L	160	160
	42	36	46	46	35,0	58	55	60	342	AS42L	160	160
S ⁴⁾	06	4	11	26	19,0	34	14	17	21	AS06S	630	630
	08	5	13	28	21,0	36	17	19	31	AS08S	630	630
	10	7	15	30	22,5	39	19	22	41	AS10S	630	630
	12	8	17	32	24,5	41	22	24	93	AS12S	630	630
	14	10	19	35	27,0	45	24	27	55	AS14S	630	630
	16	12	21	35	26,5	45	27	30	82	AS16S	400	400
	20	16	26	40	29,5	51	32	36	131	AS20S	400	400
	25	20	31	44	32,0	56	41	46	219	AS25S	400	400
	30	25	36	49	35,5	62	46	50	297	AS30S	400	400
	38	32	44	54	38,0	69	55	60	448	AS38S	315	315

¹⁾ Druckwert genannt = Artikel lieferbar

³⁾ L = Leichte Baureihe; ⁴⁾ S = Schwere Baureihe

$$\frac{\text{PN (bar)}}{10} = \text{PN (MPa)}$$

Lieferung ohne Mutter und Schneidring. Hinweise zum Bestellen von Kompletverschraubungen siehe Seite 17.

*Ergänzen Sie bitte die Bestellzeichen mit den **Kennbuchstaben** für das gewünschte Material.

Bestellzeichen-Ergänzungen		
Material	Kennbuchstaben Oberfläche und Material	Beispiel
Stahl		AS16SX
Edelstahl	71X	AS16S71X

WAS Winkel-Anschweißstutzen

Anschweiß-Anschluss / EO 24°-Anschluss

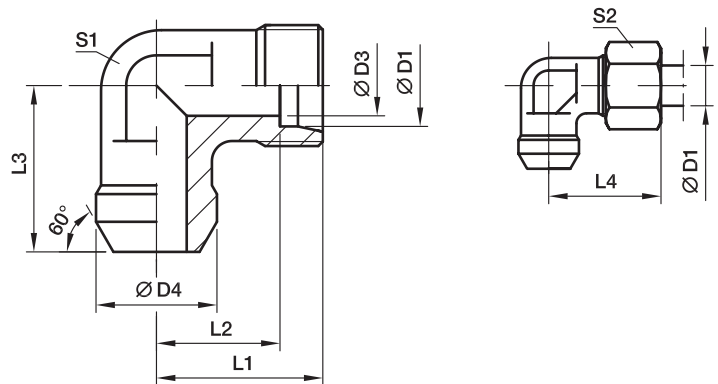

Bau- reihe	D1 	D3	D4	L1	L2	L3	L4	S1	S2	Gewicht g/1 St.	Bestellzeichen	PN (bar) ¹⁾	
												Stahl	Edelstahl
L ³⁾	06	4	10	19	12,0	19	27	12	14	20	WAS06L	315	315
	08	6	12	21	14,0	23	29	12	17	25	WAS08L	315	315
	10	8	14	22	15,0	24	30	14	19	34	WAS10L	315	315
	12	10	16	24	17,0	25	32	17	22	45	WAS12L	315	315
	15	12	19	28	21,0	30	36	19	27	81	WAS15L	315	315
	18	15	22	31	23,5	33	40	24	32	113	WAS18L	315	315
	22	19	27	35	27,5	37	44	27	36	151	WAS22L	160	160
	28	24	32	38	30,5	42	47	36	41	271	WAS28L	160	160
	35	30	40	45	34,5	49	56	41	50	113	WAS35L	160	160
	42	36	46	51	40,0	57	63	50	60	420	WAS42L	160	160
S ⁴⁾	06	4	11	23	16,0	23	31	12	17	31	WAS06S	630	630
	08	5	13	24	17,0	24	32	14	19	44	WAS08S	630	630
	10	7	15	25	17,5	25	34	17	22	59	WAS10S	630	630
	12	8	17	29	21,5	29	38	17	24	78	WAS12S	630	630
	14	10	19	30	22,0	30	40	19	27	98	WAS14S	630	630
	16	12	21	33	24,5	33	43	24	30	133	WAS16S	400	400
	20	16	26	37	26,5	37	48	27	36	192	WAS20S	400	400
	25	20	31	42	30,0	42	54	36	46	351	WAS25S	400	400
	30	25	36	49	35,5	49	62	41	50	525	WAS30S	400	400
	38	32	44	57	41,0	57	72	50	60	785	WAS38S	315	315

¹⁾ Druckwert genannt = Artikel lieferbar

³⁾ L = Leichte Baureihe; ⁴⁾ S = Schwere Baureihe

$$\frac{\text{PN (bar)}}{10} = \text{PN (MPa)}$$

Lieferung ohne Mutter und Schneidring. Hinweise zum Bestellen von Komplettverschraubungen bzw. alternativen Dichtungsmaterialien siehe Seite 17.

*Ergänzen Sie bitte die Bestellzeichen mit den **Kennbuchstaben** für das gewünschte Material.

Bestellzeichen-Ergänzungen		
Material	Kennbuchstaben Oberfläche und Material	Beispiel
Stahl		WAS16SX
Edelstahl	71X	WAS16S71X

ASK Anschweißverschraubung für Rohr

Anschweiß-Anschluss / Anschweiß-Anschluss

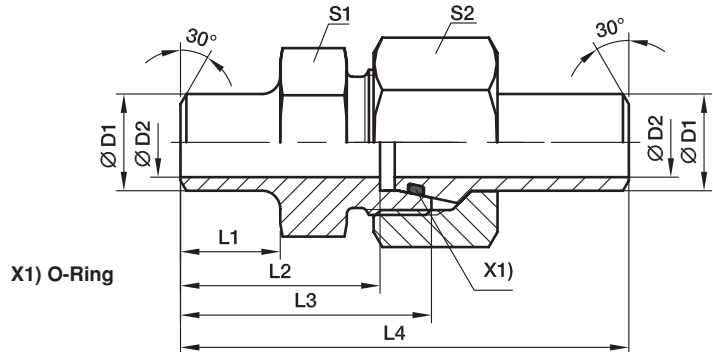

Bau- reihe	D1 	D2	L1	L2	L3	L4	S1	S2	empfohlenes Rohr	Gewicht g/1 St.	Bestellzeichen	PN (bar) ¹⁾	
												Stahl	Edelstahl
S ⁴⁾	10	8	10,0	24,5	32,0	58,0	19	22	10X1,0	75	ASK610X1S	249	242
	10	7	10,0	24,5	32,0	58,0	19	22	10X1,5	81	ASK610X1.5S	358	349
	10	6	10,0	24,5	32,0	58,0	19	22	10X2,0	86	ASK610X2S	460	447
	12	9	15,0	29,5	37,0	63,0	22	24	12X1,5	106	ASK612X1.5S	305	297
	12	8	15,0	29,5	37,0	63,0	22	24	12X2,0	107	ASK612X2S	393	383
	12	7	15,0	29,5	37,0	63,0	22	24	12X2,5	109	ASK612X2.5S	476	463
	16	13	16,5	33,0	41,5	73,5	27	30	16X1,5	166	ASK616X1.5S	234	228
	16	12	16,5	33,0	41,5	73,5	27	30	16X2,0	175	ASK616X2S	305	297
	16	11	16,5	33,0	41,5	73,5	27	30	16X2,5	184	ASK616X2.5S	372	362
	16	10	16,5	33,0	41,5	73,5	27	30	16X3,0	193	ASK616X3S	400	400
	20	16	19,0	36,5	47,0	83,5	32	36	20X2,0	301	ASK620X2S	249	242
	20	15	19,0	36,5	47,0	83,5	32	36	20X2,5	311	ASK620X2.5S	305	297
	20	14	19,0	36,5	47,0	83,5	32	36	20X3,0	316	ASK620X3S	358	349
	20	12	19,0	36,5	47,0	83,5	32	36	20X4,0	322	ASK620X4S	400	400
	25	19	19,5	39,5	51,5	92,5	41	46	25X3,0	551	ASK625X3S	294	286
	25	17	19,5	39,5	51,5	92,5	41	46	25X4,0	559	ASK625X4S	379	369
	25	15	19,5	39,5	51,5	92,5	41	46	25X5,0	589	ASK625X5S	400	400
	30	24	23,0	44,5	58,0	101,5	46	50	30X3,0	671	ASK630X3S	249	242
	30	22	23,0	44,5	58,0	101,5	46	50	30X4,0	679	ASK630X4S	323	314
	30	20	23,0	44,5	58,0	101,5	46	50	30X5,0	726	ASK630X5S	393	383
30	18	23,0	44,5	58,0	101,5	46	50	30X6,0	791	ASK630X6S	400	400	
38	30	22,0	44,0	60,0	108,0	55	60	38X4,0	988	ASK638X4S	261	254	
38	28	22,0	44,0	60,0	108,0	55	60	38X5,0	1044	ASK638X5S	315	311	
38	26	22,0	44,0	60,0	108,0	55	60	38X6,0	1108	ASK638X6S	315	315	
38	24	22,0	44,0	60,0	108,0	55	60	38X7,0	1205	ASK638X7S	315	315	

¹⁾ Druckwert genannt = Artikel lieferbar

⁴⁾ S = Schwere Baureihe

$$\frac{\text{PN (bar)}}{10} = \text{PN (MPa)}$$

*Ergänzen Sie bitte die Bestellzeichen mit den **Kennbuchstaben** für das gewünschte Material.

Bestellzeichen-Ergänzungen			
Material	Kennbuchstaben Oberfläche und Material	Beispiel	Standard-Dichtungswerk- stoff (keine zusätzl. Kenn- buchstaben erforderlich)
Stahl		ASK616X2S	NBR
Edelstahl	71	ASK616X2S71	VIT

ESV Einschweiß-Schottstutzen

EO 24° Anschluss / EO 24° Anschluss

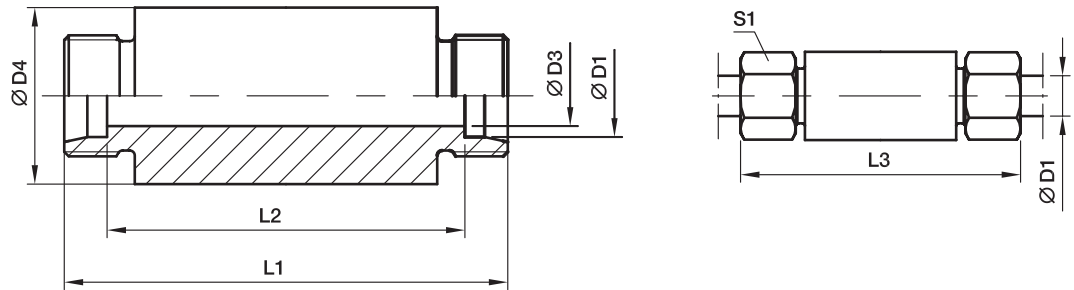

Bau- reihe	D1	D3	D4	L1	L2	L3	S1	Gewicht g/1 St.	Bestellzeichen	PN (bar) ¹⁾	
										Stahl	Edelstahl
L ³⁾	06	4	18	70	56	85	14	103	ESV06L	500	315
	08	6	20	70	56	85	17	121	ESV08L	500	315
	10	8	22	72	58	87	19	142	ESV10L	500	315
	12	10	25	72	58	87	22	176	ESV12L	400	315
	15	12	28	84	70	100	27	262	ESV15L	400	315
	18	15	32	84	69	101	32	333	ESV18L	400	315
	22	19	36	88	73	105	36	394	ESV22L	250	160
	28	24	40	88	73	106	41	448	ESV28L	250	160
	35	30	50	92	71	114	50	713	ESV35L	250	160
	42	36	60	92	70	115	60	997	ESV42L	250	160
S ⁴⁾	06	4	20	74	60	89	17	135	ESV06S	800	630
	08	5	22	74	60	89	19	163	ESV08S	800	630
	10	7	25	74	59	91	22	201	ESV10S	800	630
	12	8	28	74	59	91	24	249	ESV12S	630	630
	14	10	30	88	72	107	27	337	ESV14S	630	630
	16	12	35	88	71	107	30	441	ESV16S	630	400
	20	16	38	92	71	114	36	509	ESV20S	420	400
	25	20	45	96	72	120	46	720	ESV25S	420	400
	30	25	50	100	73	126	50	873	ESV30S	420	400
	38	32	60	104	72	133	60	1248	ESV38S	420	315

¹⁾ Druckwert genannt = Artikel lieferbar

³⁾ L = Leichte Baureihe; ⁴⁾ S = Schwere Baureihe

$$\frac{\text{PN (bar)}}{10} = \text{PN (MPa)}$$

Lieferung ohne Mutter und Schneidring. Hinweise zum Bestellen von Komplettverschraubungen bzw. alternativen Dichtungsmaterialien siehe Seite 17.

*Ergänzen Sie bitte die Bestellzeichen mit den **Kennbuchstaben** für das gewünschte Material.

Bestellzeichen-Ergänzungen		
Material	Kennbuchstaben Oberfläche und Material	Beispiel
Stahl		ESV16SX
Edelstahl	71X	ESV16S71X

SKA Schweißkegel

EO 24° Schweißkegel / Anschweiß-Anschluss

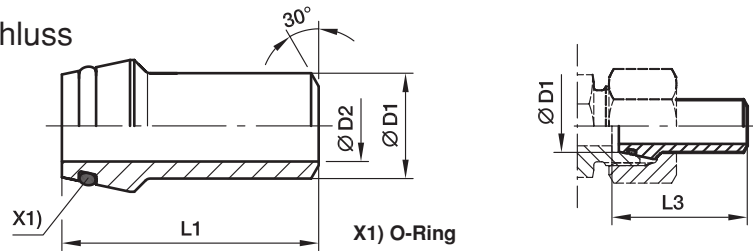

Bau- reihe	D1	D2	L1	L3	empfohlenes Rohr	Gewicht g/1 St.	Bestellzeichen	PN (bar) ¹⁾		
								Stahl	Edelstahl	
L ³⁾ /S ⁴⁾	06	3,0	31,0	31,5	6X1,5	7	SKA06X1.5	528	539	
	08	4,5	31,0	31,5	8X1,5	11	SKA08X1.5	414	424	
	08	4,0	31,0	31,5	8X2,0	11	SKA08X2	528	539	
	10	8,0	32,5	33,5	10X1,0	13	SKA10X1	249	242	
	10	7,0	32,5	33,5	10X1,5	13	SKA10X1.5	358	349	
	10	6,0	32,5	33,5	10X2,0	16	SKA10X2	460	447	
	12	9,0	32,5	33,5	12X1,5	21	SKA12X1.5	305	297	
	12	8,0	32,5	33,5	12X2,0	20	SKA12X2	393	383	
	12	7,0	32,5	33,5	12X2,5	22	SKA12X2.5	476	463	
	L ³⁾	15	11,0	34,0	34,5	15X2,0	29	SKA15X2	315	315
		15	10,0	34,0	34,5	15X2,5	31	SKA15X2.5	315	315
		18	13,0	35,5	36,5	18X2,5	40	SKA18X2.5	315	315
22		17,0	38,5	39,5	22X2,5	57	SKA22X2.5	160	160	
28		23,0	41,5	42,5	28X2,5	73	SKA28X2.5	160	160	
28		22,0	41,5	42,5	28X3,0	89	SKA28X3	160	160	
35		28,0	47,5	49,5	35X3,5	140	SKA35X3.5	160	160	
35		27,0	47,5	49,5	35X4,0	150	SKA35X4	160	160	
42		36,0	47,5	50,0	42X3,0	155	SKA42X3	160	160	
42		34,0	47,5	50,0	42X4,0	190	SKA42X4	160	160	
S ⁴⁾		14	10,0	38,5	39,5	14X2,0	26	SKA14X2	343	334
		14	8,0	38,5	39,5	14X3,0	33	SKA14X3	487	474
	16	13,0	39,0	40,5	16X1,5	32	SKA16X1.5	234	228	
	16	12,0	39,0	40,5	16X2,0	31	SKA16X2	305	297	
	16	11,0	39,0	40,5	16X2,5	38	SKA16X2.5	372	362	
	16	10,0	39,0	40,5	16X3,0	41	SKA16X3	400	400	
	20	16,0	45,0	47,0	20X2,0	57	SKA20X2	249	242	
	20	15,0	45,0	47,0	20X2,5	57	SKA20X2.5	305	297	
	20	14,0	45,0	47,0	20X3,0	64	SKA20X3	358	349	
	20	13,0	45,0	47,0	20X3,5	71	SKA20X3.5	400	400	
	20	12,0	45,0	47,0	20X4,0	78	SKA20X4	400	400	
	25	19,0	49,5	53,0	25X3,0	89	SKA25X3	294	286	
	25	18,0	49,5	53,0	25X3,5	100	SKA25X3.5	337	328	
	25	17,0	49,5	53,0	25X4,0	111	SKA25X4	379	369	
	25	15,0	49,5	53,0	25X5,0	125	SKA25X5	400	400	
	30	24,0	52,0	57,0	30X3,0	113	SKA30X3	249	242	
	30	22,0	52,0	57,0	30X4,0	141	SKA30X4	323	314	
	30	20,0	52,0	57,0	30X5,0	166	SKA30X5	393	383	
	30	18,0	52,0	57,0	30X6,0	188	SKA30X6	400	400	
	38	32,0	56,5	64,0	38X3,0	163	SKA38X3	200	195	
	38	30,0	56,5	64,0	38X4,0	209	SKA38X4	261	254	
	38	28,0	56,5	64,0	38X5,0	247	SKA38X5	315	315	
	38	26,0	56,5	64,0	38X6,0	270	SKA38X6	315	315	
	38	24,0	56,5	64,0	38X7,0	270	SKA38X7	315	315	

¹⁾ Druckwert genannt = Artikel lieferbar

³⁾ L = Leichte Baureihe; ⁴⁾ S = Schwere Baureihe

$$\frac{\text{PN (bar)}}{10} = \text{PN (MPa)}$$

*Ergänzen Sie bitte die Bestellzeichen mit den **Kennbuchstaben** für das gewünschte Material.

Bestellzeichen-Ergänzungen			
Material	Kennbuchstaben Oberfläche und Material	Beispiel	Standard-Dichtungswerk- stoff (keine zusätzl. Kenn- buchstaben erforderlich)
Stahl		SKA16X2	NBR
Edelstahl	71	SKA16X271	VIT

SKAR Schweißkegel-Reduzierung

EO 24° Schweißkegel / Anschweiß-Anschluss

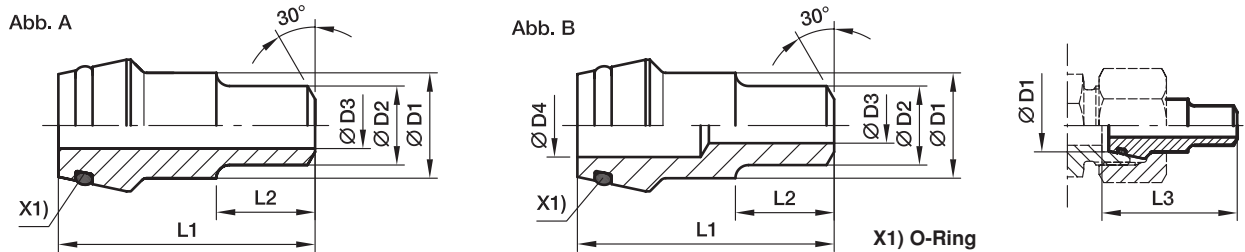

Bau- reihe	D1 	D2	D3	D4	L1	L2	L3	Fig.	Gewicht g/1 St.	Bestellzeichen	PN (bar) ¹⁾	
											Stahl	Edelstahl
L ³⁾ /S ⁴⁾	08	06	3		31,0	12	31,5	A	14	SKAR08/06X1.5	528	539
	10	06	3	5	32,5	12	33,5	B	15	SKAR10/06X1.5	528	539
	10	08	5		32,5	12	33,5	A	16	SKAR10/08X1.5	414	424
	10	08	4		32,5	12	33,5	A	17	SKAR10/08X2	528	539
	12	08	5		32,5	14	33,5	A	18	SKAR12/08X1.5	414	424
	12	08	4	6	32,5	14	33,5	B	20	SKAR12/08X2	528	539
	12	10	7		32,5	14	33,5	A	18	SKAR12/10X1.5	358	349
S ⁴⁾	16	10	6		39,0	15	40,5	A	43	SKAR16/10X2	400	400
	16	12	9		39,0	15	40,5	A	45	SKAR16/12X1.5	305	297
	16	12	8		39,0	15	40,5	A	47	SKAR16/12X2	393	383
	16	12	7		39,0	15	40,5	A	49	SKAR16/12X2.5	400	400
	20	12	9		45,0	17	47,0	A	76	SKAR20/12X1.5	305	297
	20	12	8		45,0	17	47,0	A	78	SKAR20/12X2	393	383
	20	12	7		45,0	17	47,0	A	80	SKAR20/12X2.5	400	400
	20	12	6		45,0	17	47,0	A	86	SKAR20/12X3	400	400
	20	16	12		45,0	17	47,0	A	74	SKAR20/16X2	305	297
	20	16	11		45,0	17	47,0	A	76	SKAR20/16X2.5	372	362
	20	16	10		45,0	17	47,0	A	78	SKAR20/16X3	400	400
	25	12	9		49,5	20	53,0	A	117	SKAR25/12X1.5	305	297
	25	12	8		49,5	20	53,0	A	121	SKAR25/12X2	393	383
	25	12	7		49,5	20	53,0	A	125	SKAR25/12X2.5	400	400
	25	12	6	15	49,5	20	53,0	B	129	SKAR25/12X3	400	400
	25	16	12		49,5	20	53,0	A	115	SKAR25/16X2	305	297
	25	16	11		49,5	20	53,0	A	120	SKAR25/16X2.5	372	362
	25	16	10		49,5	20	53,0	A	123	SKAR25/16X3	400	400
	25	20	16		49,5	20	53,0	A	94	SKAR25/20X2	249	242
	25	20	15		49,5	20	53,0	A	104	SKAR25/20X2.5	305	297
	25	20	14		49,5	20	53,0	A	114	SKAR25/20X3	358	349
	25	20	12		49,5	20	53,0	A	124	SKAR25/20X4	400	400
	30	12	9	22	52,0	22	57,0	B	135	SKAR30/12X1.5	305	297
	30	12	8	22	52,0	22	57,0	B	145	SKAR30/12X2	323	383
	30	12	6	22	52,0	22	57,0	B	155	SKAR30/12X3	400	400
	30	16	12		52,0	22	57,0	A	166	SKAR30/16X2	305	297
	30	16	11		52,0	22	57,0	A	176	SKAR30/16X2.5	323	362
	30	20	16		52,0	22	57,0	A	149	SKAR30/20X2	249	242
	30	20	15		52,0	22	57,0	A	159	SKAR30/20X2.5	305	297
	30	20	14		52,0	22	57,0	A	169	SKAR30/20X3	358	349
	30	20	12		52,0	22	57,0	A	184	SKAR30/20X4	400	400
	30	25	20		52,0	22	57,0	A	141	SKAR30/25X2.5	249	242
30	25	19		52,0	22	57,0	A	156	SKAR30/25X3	294	286	
30	25	17		52,0	22	57,0	A	168	SKAR30/25X4	379	369	

SKAR Schweißkegel-Reduzierung

EO 24° Schweißkegel / Anschweiß-Anschluss

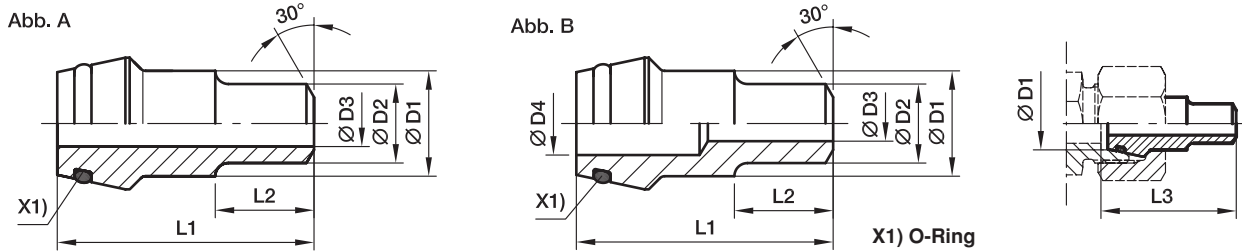

Bau- reihe	D1	D2	D3	D4	L1	L2	L3	Fig.	Gewicht g/1 St.	Bestellzeichen	PN (bar) ¹⁾	
											Stahl	Edelstahl
S ⁴⁾	38	12	9	28	56,5	26	64,0	B	219	SKAR38/12X1.5	305	297
	38	12	8	28	56,5	26	64,0	B	234	SKAR38/12X2	315	315
	38	12	6	28	56,5	26	64,0	B	249	SKAR38/12X3	315	315
	38	16	12		56,5	26	64,0	A	279	SKAR38/16X2	305	297
	38	16	11		56,5	26	64,0	A	294	SKAR38/16X2.5	315	315
	38	16	10		56,5	26	64,0	A	309	SKAR38/16X3	315	315
	38	20	16		56,5	26	64,0	A	263	SKAR38/20X2	249	242
	38	20	15		56,5	26	64,0	A	278	SKAR38/20X2.5	305	297
	38	20	14		56,5	26	64,0	A	293	SKAR38/20X3	315	315
	38	20	12		56,5	26	64,0	A	299	SKAR38/20X4	315	315
	38	25	20		56,5	26	64,0	A	242	SKAR38/25X2.5	249	242
	38	25	19		56,5	26	64,0	A	262	SKAR38/25X3	294	286
	38	25	17		56,5	26	64,0	B	285	SKAR38/25X4	315	315
	38	30	24		56,5	26	64,0	A	256	SKAR38/30X3	249	242
	38	30	22		56,5	26	64,0	A	286	SKAR38/30X4	315	315
	38	30	20		56,5	26	64,0	A	316	SKAR38/30X5	315	315

¹⁾ Druckwert genannt = Artikel lieferbar

³⁾ L = Leichte Baureihe; ⁴⁾ S = Schwere Baureihe

$$\frac{\text{PN (bar)}}{10} = \text{PN (MPa)}$$

*Ergänzen Sie bitte die Bestellzeichen mit den **Kennbuchstaben** für das gewünschte Material.

Bestellzeichen-Ergänzungen			
Material	Kennbuchstaben Oberfläche und Material	Beispiel	Standard-Dichtungswerk- stoff (keine zusätzl. Kenn- buchstaben erforderlich)
Stahl		SKAR16/12X2	NBR
Edelstahl	71	SKAR16/12X271	VIT

SKA-ORB Schweißkegel (orbital)

EO 24°-Schweißkegel / Anschweiß-Anschluss (orbital)

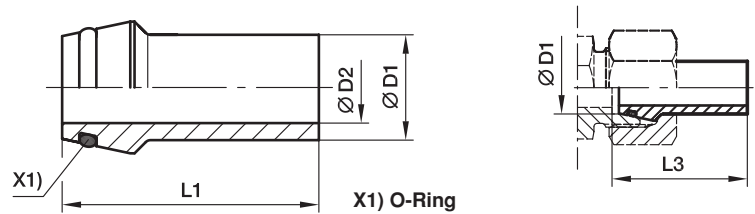

Baureihe	D1	D2	L1	L3	empfohlenes Rohr	Gewicht g/1 St.	Bestellzeichen	PN (bar) ¹⁾
								Edelstahl
L ³⁾ /S ⁴⁾	10	6,0	37,5	38,5	10X1,5	13	SKA10X1.5ORB	358
	12	8,0	37,5	38,5	12X1,5	21	SKA12X1.5ORB	305
	12	8,0	37,5	38,5	12X2,0	255	SKA12X2ORB	393
L ³⁾	18	13,0	38,0	39,0	18X2,0	43	SKA18X2ORB	290
	22	17,0	38,5	39,5	22X2,0	50	SKA22X2ORB	250
	28	22,0	41,5	42,5	28X2,0	69	SKA28X2ORB	204
	42	36,0	47,5	50,0	42X3,0	160	SKA42X3ORB	182
S ⁴⁾	16	12,0	39,0	40,5	16X2,0	310	SKA16X2ORB	305
	20	14,0	45,0	47,0	20X3,0	640	SKA20X3ORB	358
	25	19,0	49,5	53,0	25X3,0	890	SKA25X3ORB	294

¹⁾ Druckwert genannt = Artikel lieferbar

³⁾ L = Leichte Baureihe; ⁴⁾ S = Schwere Baureihe

$\frac{\text{PN (bar)}}{10} = \text{PN (MPa)}$

*Ergänzen Sie bitte die Bestellzeichen mit den **Kennbuchstaben** für das gewünschte Material.

Bestellzeichen-Ergänzungen			
Material	Kennbuchstaben Oberfläche und Material	Beispiel	Standard-Dichtungswerkstoff (keine zusätzl. Kennbuchstaben erforderlich)
Edelstahl	71	SKA16X2ORB71	VIT

SKA-RB Schweißkegel-Rohrbogen

EO 24° Schweißkegel / Anschweiß-Anschluss

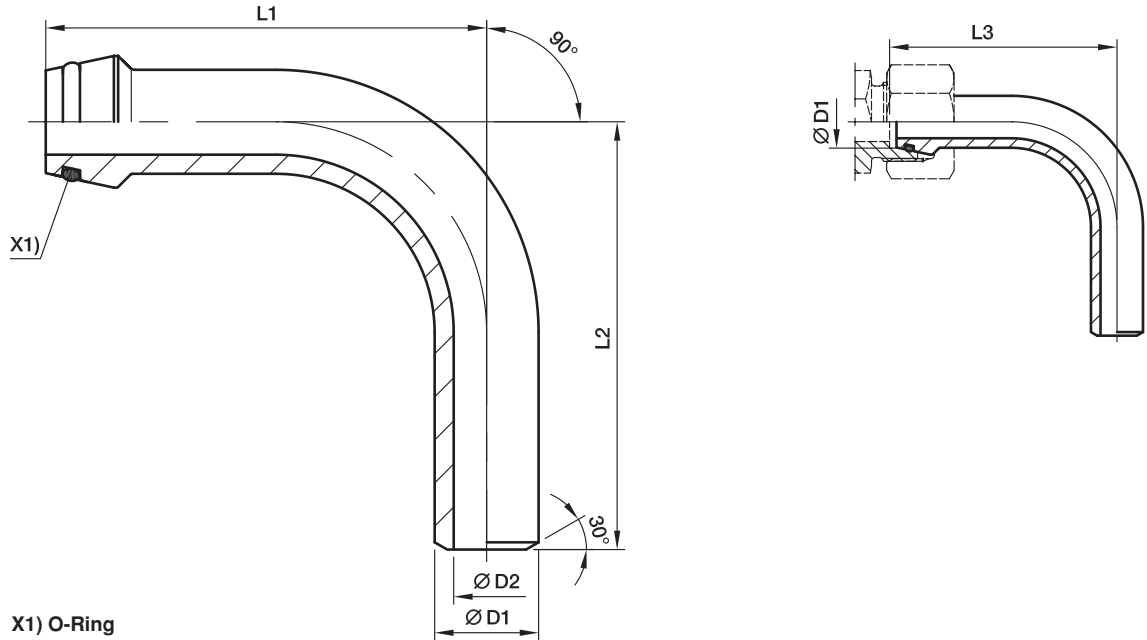

Bau- reihe	D1	D2	L1	L2	L3	empfohlenes Rohr	Gewicht g/1 St.	Bestellzeichen	PN (bar) ¹⁾	
									Stahl	Edelstahl
S ⁴⁾	10	6	49	45	50,0	10X2	38	SKA10X2RB	460	447
	12	7	51	50	52,0	12X2,5	50	SKA12X2.5RB	476	463
	16	10	67	60	68,5	16X3	105	SKA16X3RB	400	400
	20	12	85	65	87,0	20X4	217	SKA20X4RB	400	400
	25	17	85	85	88,5	25X4	295	SKA25X4RB	379	369
	25	15	85	85	88,5	25X5	353	SKA25X5RB	400	400
	30	22	111	110	116,0	30X4	469	SKA30X4RB	323	314
	30	20	111	110	116,0	30X5	568	SKA30X5RB	393	383
	38	28	136	130	143,5	38X5	876	SKA38X5RB	315	315
	38	26	136	130	143,5	38X6	1045	SKA38X6RB	315	315

¹⁾ Druckwert genannt = Artikel lieferbar

⁴⁾ S = Schwere Baureihe

$\frac{PN \text{ (bar)}}{10} = PN \text{ (MPa)}$

*Ergänzen Sie bitte die Bestellzeichen mit den **Kennbuchstaben** für das gewünschte Material.

Bestellzeichen-Ergänzungen			
Material	Kennbuchstaben Oberfläche und Material	Beispiel	Standard-Dichtungswerk- stoff (keine zusätzl. Kenn- buchstaben erforderlich)
Stahl		SKA16X3RB	NBR
Edelstahl	71	SKA16X3RB71	VIT

OR O-Ringe für Schweißkegel

Für Type: SKA, SKAR, SKA-RB

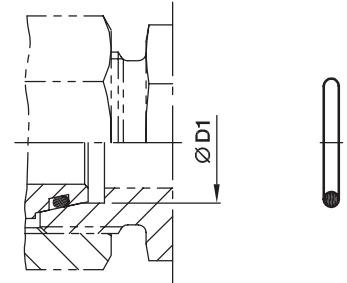

Bau- reihe	D1 	O-Ring NBR Shore-Härte ca. 90	O-Ring FKM Shore-Härte ca. 90
L ³⁾	06	OR4.5X1.5X	OR4.5X1.5VITX
	08	OR6.5X1.5X	OR6.5X1.5VITX
	10	OR8.5X1.5X	OR8X1.5VITX
	12	OR10.5X1.5X	OR10X1.5VITX
	15	OR12.5X1.5X	OR12X2VITX
	18	OR16X2X	OR15X2VITX
	22	OR20X2X	OR20X2VITX
	28	OR26X2X	OR26X2VITX
	35	OR32X2.5X	OR32X2.5VITX
	42	OR39X2.5X	OR38X2.5VITX
S ⁴⁾	06	OR4.5X1.5X	OR4.5X1.5VITX
	08	OR6.5X1.5X	OR6.5X1.5VITX
	10	OR8.5X1.5X	OR8X1.5VITX
	12	OR10.5X1.5X	OR10X1.5VITX
	14	OR12X2X	OR11X2VITX
	16	OR14X2X	OR13X2VITX
	20	OR17X2.5X	OR16.3X2.4VITX
	25	OR22X2.5X	OR20.3X2.4VITX
	30	OR27X2.5X	OR25.3X2.4VITX
	38	OR35X2.5X	OR33.3X2.4VITX

³⁾ L = Leichte Baureihe; ⁴⁾ S = Schwere Baureihe