



Faltenbälge

(Standard-Lieferprogramm)

01-106A



Faltenbälge (Standard-Lieferprogramm)

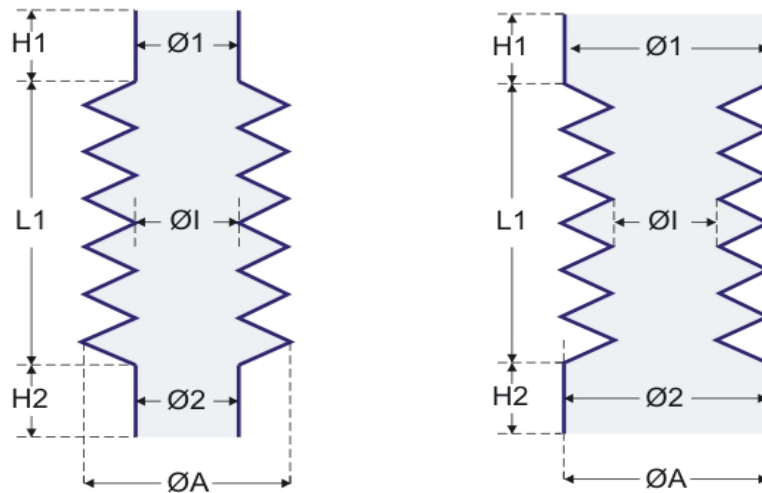

Form-Nr.	Artikel-Nr.	Anschluß-Ø 1 (kleineres Maß)	Anschlußlänge H1	Anschluß-Ø 2 (größeres Maß)	Anschlußlänge H2	Ø1	Ø1-konisch	ØA	ØA-konisch	Länge L1 (gestreckt)	Länge L2 (gestaucht)
7552	121001-0303	3	8	9	8	12		23		110	40
5392	121002-0168	5	12	68	18	12		26		50	15
2390	121001-1141	5	8	22	10	13		29		35	5
2194	121001-0961	5	14	8	12	15		25		220	100
2370	121002-0216	7	8	21	4,5	11	18	30	41	50	15
7468	321002-0116	7	20	50	20	21	40	40	80	100	20
1672	121001-1042	8	15	8	15	10		26		110	20
7837	121002-0447	8	6	25	15	10	18	20	34	90	30
1677	121001-0150	9	10	16	10	12		31		40	5
2139	121001-1637	9	3	9	3	12		25		28	7
8812	121001-0456	9	10	18	10	12		28		120	30
1431	121002-0043	10	12	35	10	25	28	47	56	80	10
6808	321002-0294	10	10	102	10	20	80	52	137	160	40
1456	321002-0199	10	10	24	12	14	25	37	60	85	25
2410	321002-0172	10	18	48	18	20	30	40	69	75	15
1372	121002-0113	10	5	64	23	18	32	32	44	50	8
8235	121001-1226	10	10	16	10	16		27		40	15
2576	121002-0185	11	10	30	6	15	24	32	46	90	20
6936	121001-0299	11	5	22	12	22		42		140	30
1200	121001-1429	12	4	29	12	22		40		40	8

Faltenbälge (Standard-Lieferprogramm)

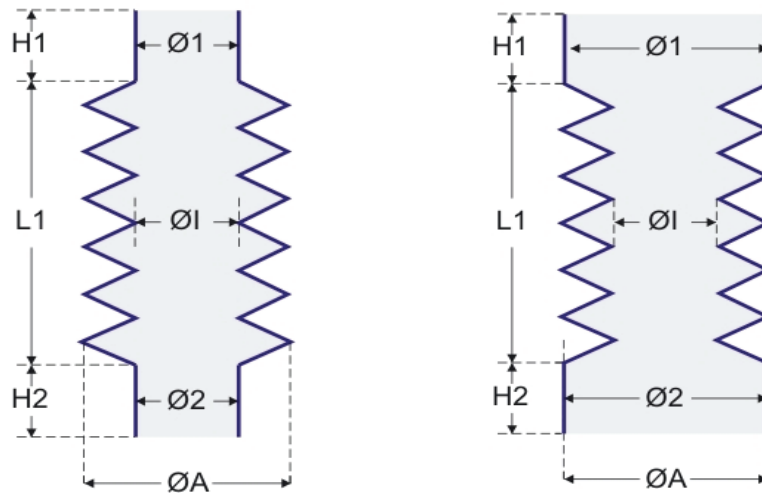

Form-Nr.	Artikel-Nr.	Anschluß-Ø 1 (kleineres Maß)	Anschlußlänge H1	Anschluß-Ø 2 (größeres Maß)	Anschlußlänge H2	ØI	ØI-konisch	ØA	ØA-konisch	Länge L1 (gestreckt)	Länge L2 (gestaucht)
1270	121001-0161	12	14	17	14	21		35		70	17
2059	321003-0065	12	9	12	9			23		10	
7865	121001-0698	12		12		12		26		70	20
2745	121002-0145	14	10	53	8	20	34	38	55	90	25
1304	121002-0061	14	11	74	11	26	62	37	82	85	30
2441	121001-1083	14	9	56	9	50		76		200	25
3283	121001-0633	14	23	30	23	26		51		220	50
6570	321003-0101	14	10	36	10			62		27	
6422	321001-0389	14	6	26	12	24		45		80	20
8773	121001-0298	14	3	14	3	14		30		45	14
9751	121001-0009	14	18	19	18	18		32		160	45
6111	321002-0234	15	20	44	8	25	40	44	74	90	20
10212	321002-0092	15	15	76	15	50	80	70	100	120	30
5040	321002-0035	15	15	60	12	30	50	50	80	110	25
5810	321001-0789	15	10	15	10	15		29		50	15
2168	321001-0373	15	10	15	10	16		36		180	50
1489	121001-0048	15	18	20	23	20		46		340	72
2693	124002-0021	16	15	146	7	30	120	62	180	230	30
3391	121001-1655	16	10	30	10	30		51		85	10
3776	121001-1087	16	10	48	20	30		76		350	40

Faltenbälge (Standard-Lieferprogramm)

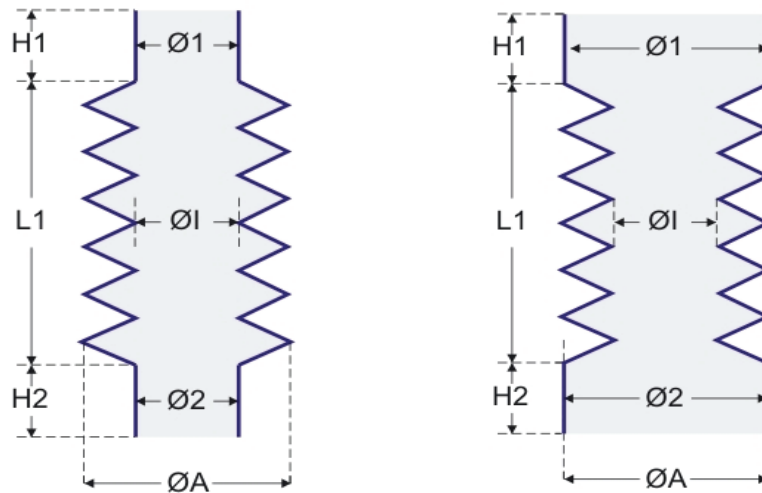

Form-Nr.	Artikel-Nr.	Anschluß-Ø 1 (kleineres Maß)	Anschlußlänge H1	Anschluß-Ø 2 (größeres Maß)	Anschlußlänge H2	Ø1	Ø1-konisch	ØA	ØA-konisch	Länge L1 (gestreckt)	Länge L2 (gestaucht)
2275	121001-0285	16	10	16	10	20		36		200	50
6372	321002-0312	16	15	27	15	18	29	31	53	140	40
8343	121002-0455	16	12	100	14	27	93	50	138	170	50
1493	121003-0296	16	10	16	10			34		18	
1608	121002-0280	16	12	41	12	20	40	42	68	100	20
6807	121001-0991	16		25		20		41		100	25
2360	121002-0125	17	14	34	25	24	31	44	54	95	20
3466	121001-0747	17	14	35	14	35		54		123	30
6682	121001-0590	17	15	45	15	28		45		230	50
3308	121003-0042	18	13	18	13			35		18	
1164	121002-0179	18	18	48	20	30	50	49	87	120	15
5821	121002-0104	18	18	38	10	25	34	57	74	170	20
1358	321002-0259	18	30	35	15	22	36	40	58	80	20
7674	321001-1149	18	7	54	11	49		82		130	30
1719	121001-0927	18	25	48	17	35		66		75	15
2001	121001-0429	18	10	44	11	22		44		55	10
1107	121002-0413	19	8	32	8	24	32	56	62	96	22
9370	321001-1059	19	13	19	13	20		42		100	20
1352	321001-1034	19	8	19	8	25		39		45	15
10895	321001-0642	19	10	38	10	23		48		310	80

Faltenbälge (Standard-Lieferprogramm)

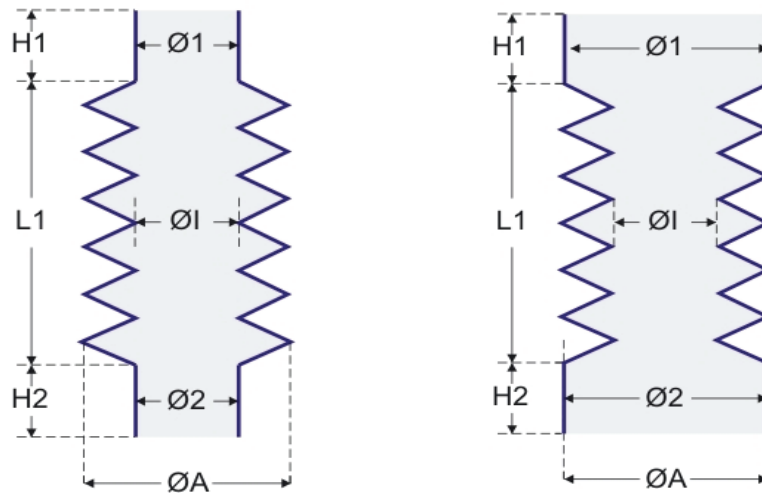

Form-Nr.	Artikel-Nr.	Anschluß-Ø 1 (kleineres Maß)	Anschlußlänge H1	Anschluß-Ø 2 (größeres Maß)	Anschlußlänge H2	Ø1	Ø1-konisch	ØA	ØA-konisch	Länge L1 (gestreckt)	Länge L2 (gestaucht)
3735	124001-1042	20	50	20	50	20		36,5		500	180
5285	121001-0278	20	6	22	18	24		50		320	70
1495	321003-0105	20	13	20	13			39		32	
1658	321002-0370	20	14	66	12	40	52	55	72	60	20
8509	321002-0003	20	25	40	12	35	50	60	77	225	60
6280	321001-1556	20	12	34	21	30		50		130	40
8535	321001-0863	20	8	36	8	38		55		70	30
3535	321001-0672	20	12	20	12	20		35		30	10
1874	321001-0109	20	18	20	18	24		43		135	40
2577	121002-0105	20	10	30	6	24	26	40	46	75	15
8901	121002-0247	21	12	55	16	35		55	73	45	10
3295	321002-0529	21	13	65	15	24	40	46	69	210	60
5280	121002-0029	21	15	70	15	25	39	50	70	290	50
12195	121001-1465	21	3	21	2	21		45		440	75
2008	121003-0106	22	60	22	90			39		30	
1572	321002-0541	22	15	34	15	26	28	43	54	60	20
1542	321001-1228	22	9	36	9	30		54		70	20
2171	321001-0813	22	14	24	14	27		44		160	60
2440	321001-0202	22	9	49	12	50		81		170	35
5128	321002-0141	22	15	90	15	54	72	90	114	190	40

Faltenbälge (Standard-Lieferprogramm)

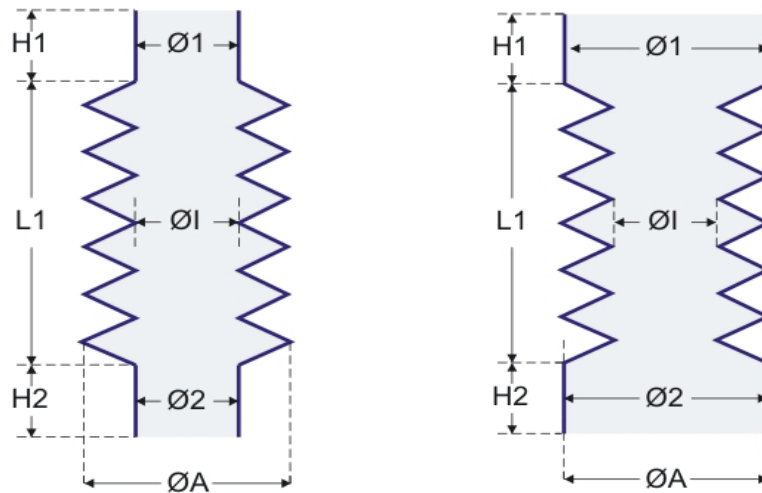

Form-Nr.	Artikel-Nr.	Anschluß-Ø 1 (kleineres Maß)	Anschlußlänge H1	Anschluß-Ø 2 (größeres Maß)	Anschlußlänge H2	Ø1	Ø1-konisch	ØA	ØA-konisch	Länge L1 (gestreckt)	Länge L2 (gestaucht)
3018	121001-1586	22	15	65	25	58		91		310	60
6240	121001-0748	22	6	22	6	24		32		14	6
5629	121001-0133	22	15	30	15	26		49		300	60
1978	121001-1023	24	15	70	12	72		100		185	35
5056	121001-0301	24	8	24	8	26		46		70	15
1040	121001-0104	24	20	24	20	24		47		235	50
3382	321002-0097	24	12	60	12	32	45	50	79	70	20
2147	321001-0573	24	13	35	12	40		79		300	60
3598	321002-0155	24	25	74	18	30	70	65	109	240	70
2627	321001-0858	24	15	24	15	30		51		110	30
1407	321001-0854	24	15	24	15	30		44		175	70
3604	321001-0842	24	12	32	12	25		49		180	60
3048	121002-0264	24	15	45	15	28	48	50	74	200	45
3326	121002-0080	24	10	50	10	30	35	40	50	40	10
7001	121001-0241	24	8	24	8	24		38		230	70
8968	324002-0073	25	15	115	15	30	118	62	165	310	50
1437	321003-0079	25	13	25	13			49		21	
6487	321002-0277	25	13	80	15	45	60	66	88	60	30
1983	321002-0266	25	8	90	12	48	60	70	99	175	45
2401	321002-0147	25	17	52	20	30	40	54	73	100	30

Faltenbälge (Standard-Lieferprogramm)

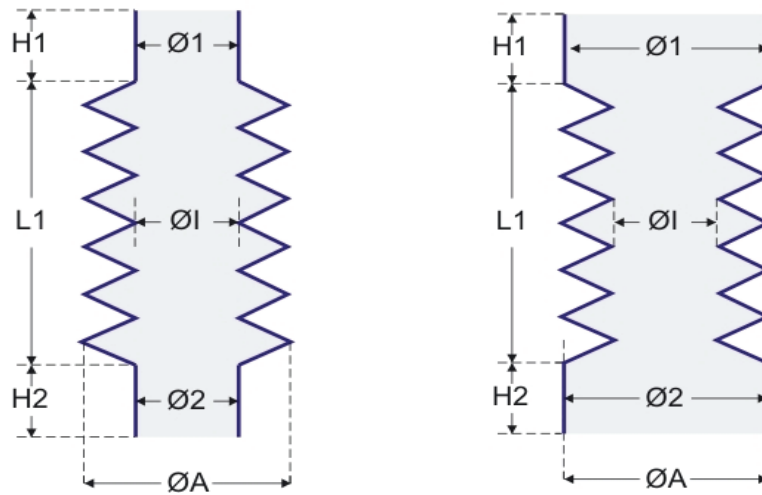

Form-Nr.	Artikel-Nr.	Anschluß-Ø 1 (kleineres Maß)	Anschlußlänge H1	Anschluß-Ø 2 (größeres Maß)	Anschlußlänge H2	Ø1	Ø1-konisch	ØA	ØA-konisch	Länge L1 (gestreckt)	Länge L2 (gestaucht)
10896	321001-0620	25	10	45	10	28		56		350	80
3315	321001-0282	25	26	25	26	28		49		300	100
1318	321001-0767	25	15	25	15	28		48		60	15
6281	124001-0361	25	15	45	20	50		70		370	110
1088	121002-0070	25	13	58	15	30	45	50	88	110	18
5497	121002-0010	25	18	65	18	32	42	50	79	85	15
9990	121001-1449	25	8	25	8	30		48		50	15
2247	121001-0589	25	25	25	25	25		41		250	75
7866	121001-0300	25		25		21		44		220	40
6853	121001-0236	25	13	38	13	30		54		130	25
8735	121001-0047	25	13	25	13	25		38		145	60
11162	321001-1011	26	10	42	11	55		90		150	30
3332	121001-0820	26	5	26	5	46		70		190	40
6055	121001-0993	27	15	122	15	115		149		250	45
1448	121003-0238	28	22	28	22			49		22	
2504	121002-0228	28	12	56	15	34	40	57	81	120	30
3358	321002-0188	28	15	82	15	40	70	70	109	120	30
3293	321001-0871	28	10	40	10	32		51		50	20
3739	321001-0760	28	14	40	14	40		68		90	20
1274	321002-0069	28	20	48	20	35	50	58	80	160	40

Faltenbälge (Standard-Lieferprogramm)

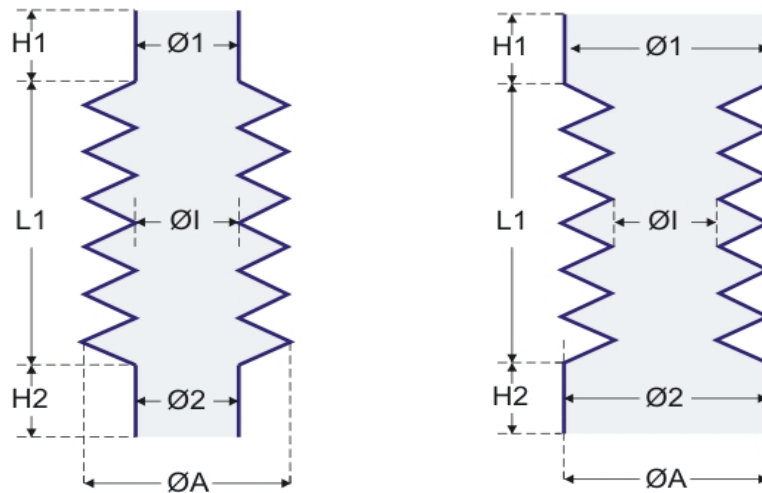

Form-Nr.	Artikel-Nr.	Anschluß-Ø 1 (kleineres Maß)	Anschlußlänge H1	Anschluß-Ø 2 (größeres Maß)	Anschlußlänge H2	ØI	ØI-konisch	ØA	ØA-konisch	Länge L1 (gestreckt)	Länge L2 (gestaucht)
3582	321001-0944	28	10	48	10	35		58		60	20
1678	321001-0756	28	15	35	15	35		64		350	100
5047	321002-0539	28	20	58	20	36	36	60	79	110	25
9253	124001-0872	28	20	45	18	30		67		440	110
2800	121001-0917	28	12	28	12	38		61		170	50
3588	121001-0421	28	10	28	10	30		59		200	25
9314	121001-0269	28	11	36	11	27		48		122	42
5615	321001-0243	29	20	36	15	36		55		230	60
1427	121001-0062	29	15	38	15	30		64		400	80
8557	124001-1928	30	10	100	12	140		180		300	70
5533	124001-0195	30	15	30	15	23		46		530	100
3636	321001-0355	30	15	40	15	40		59		60	20
9960	324002-0390	30	15	146	25	50	145	84	189	260	50
7673	324002-0030	30	18	106	45	35	52	62	81	320	80
3622	324001-0091	30	20	30	20	30		47		500	140
8792	321003-0074	30	13	72	13			88		15	
1056	321003-0054	30	20	30	20			53		16	
10918	321001-0907	30	9	50	9	40		80		170	30
6858	321001-0528	30	15	30	15	31		58		140	30
5515	321001-0527	30	15	30	15	30		59		200	40

Faltenbälge (Standard-Lieferprogramm)

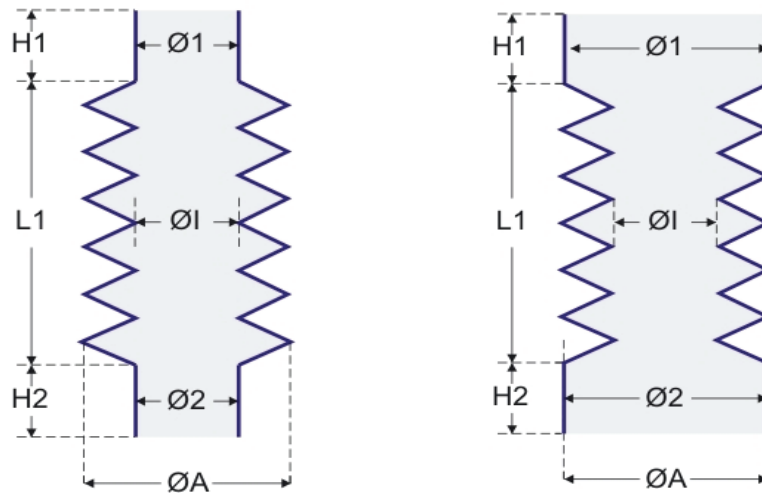

Form-Nr.	Artikel-Nr.	Anschluß-Ø 1 (kleineres Maß)	Anschlußlänge H1	Anschluß-Ø 2 (größeres Maß)	Anschlußlänge H2	ØI	ØI-konisch	ØA	ØA-konisch	Länge L1 (gestreckt)	Länge L2 (gestaucht)
10045	321001-0136	30	15	60	10	32		58		60	20
9376	121001-1640	30	20	50	15	31		48		330	145
5607	324001-0265	30	25	45	25	48		89		440	80
3215	321001-0258	30	12	40	12	50		74		150	35
5531	121002-0028	30	4	50	4	36	40	52	71	85	20
7838	124001-1819	31	7	38	7	35		60		225	40
7303	321001-0231	31	12	69	16	35		69		270	60
7298	124001-0370	31	13	69	16	34		75		680	110
2543	121001-1132	31	13	31	13	32		48		35	25
2448	121001-0080	32	12	32	12	40		76		300	35
7441	321001-0395	32	13	42	13	43		59		210	90
2798	321001-1468	32	8	45	12	50		89		170	30
3740	321001-0582	32	14	40	14	40		68		80	20
6702	121001-0544	32	10	36	10	35		48		95	30
6703	121001-0464	32	10	32	10	32		52		240	50
3407	121001-0438	32	6	42	8	38		58		230	45
1119	121001-0203	32	18	32	18	35		55		156	32
3338	121001-0201	32	15	32	15	36		54		75	15
3152	121001-1351	34	12	43	12	35		61		70	20
5878	321002-0049	34	20	74	14	50	84	80	109	130	30

Faltenbälge (Standard-Lieferprogramm)

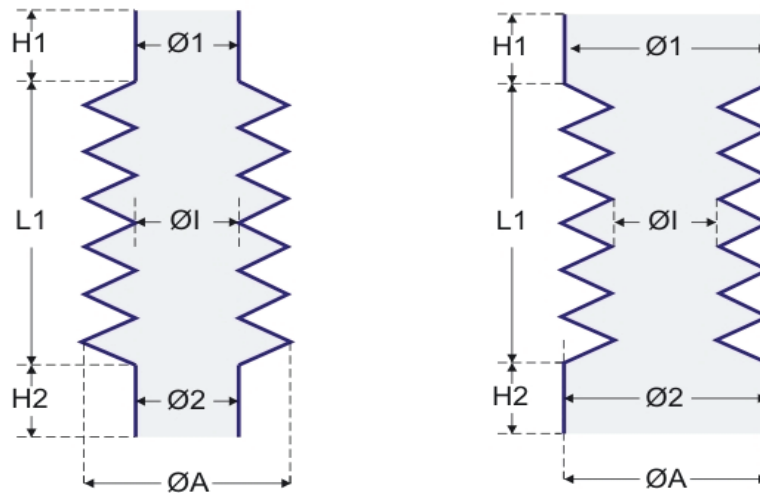

Form-Nr.	Artikel-Nr.	Anschluß-Ø 1 (kleineres Maß)	Anschlußlänge H1	Anschluß-Ø 2 (größeres Maß)	Anschlußlänge H2	Ø1	Ø1-konisch	ØA	ØA-konisch	Länge L1 (gestreckt)	Länge L2 (gestaucht)
8620	321001-0504	34	15	78	18	70		92		220	90
3355	321001-0382	34	12	34	12	48		74		180	40
3623	121001-0524	35	10	35	10	35		61		75	15
1013	321003-0036	35	23	35	23			62		25	
8135	321001-1315	35	12	35	12	56		73		50	20
1464	321002-0343	35	25	99	25	40	70	79	128	180	35
8587	124001-1308	35	14	50	15	60		110		360	60
8159	124001-0770	35	16	130	25	88		140		240	40
7158	121001-0811	35	15	35	15	30		59		180	35
6935	124001-0248	36	15	36	15	34		76		400	100
3423	121001-0506	36	22	38	28	30		46		210	50
2081	121001-0239	36	12	36	12	34		61		280	50
5719	321001-0682	36	20	46	20	46		69		100	30
1505	121003-0057	36	28	36	28			63		29	
9618	121001-0744	36	25	55	20	62		85		175	50
3593	121001-0108	36		40		49		69		130	30
1258	121001-1409	37	20	37	20	37		57		215	85
3889	121001-1517	37	12	49	12	43		59		90	20
6798	124001-0221	38	15	38	15	40		70		470	110
1327	121001-0408	38	8	38	8	38		60		40	8

Faltenbälge (Standard-Lieferprogramm)

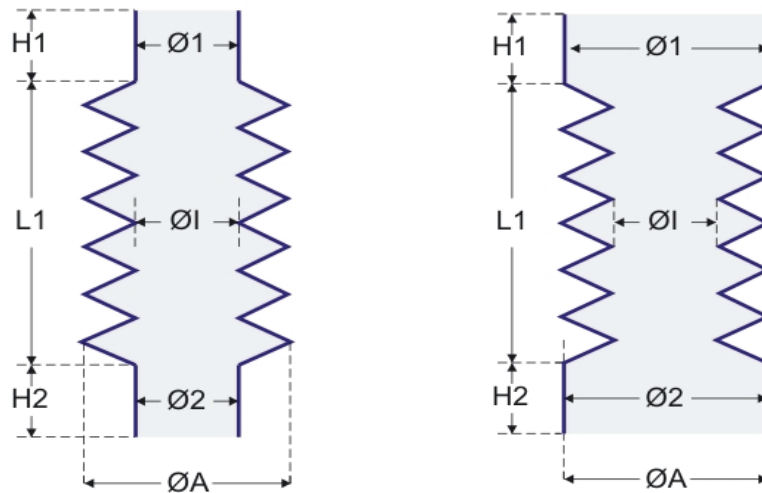

Form-Nr.	Artikel-Nr.	Anschluß-Ø 1 (kleineres Maß)	Anschlußlänge H1	Anschluß-Ø 2 (größeres Maß)	Anschlußlänge H2	ØI	ØI-konisch	ØA	ØA-konisch	Länge L1 (gestreckt)	Länge L2 (gestaucht)
1095	321002-0237	38	20	78	13	40	72	70	118	170	40
5600	324001-0322	38	15	53	15	58		94		300	60
5149	321002-0397	38	12	115	12	42	90	88	116	160	40
6802	321001-0962	38	15	38	15	46		77		90	20
8920	321001-0688	38	10	38	10	40		77		420	80
7815	321001-0614	38	10	38	10	45		70		130	25
5578	321001-0318	38	15	38	15	60		88		120	25
6822	124001-0335	38	20	75	20	84		120		270	50
5138	121002-0320	38	12	58	12	43	48	68	79	100	15
7582	121001-0809	38	11	52	11	45		62		240	70
7919	121001-0148	38	19	58	18	50		70		85	25
7297	324001-0246	39	13	84	17	50		95		550	140
7302	321001-0375	39	12	84	16	50		90		250	50
2493	121002-0081	39	10	62	10	40	40	60	68	90	10
6690	121001-0027	40	14	40	14	35		65		140	20
2305	321001-0669	40	15	60	15	45		84		370	50
9856	321001-0348	40	8	40	8	40		85		350	55
7469	321001-1098	40	11	50	10	58		87		180	40
9029	321001-0781	40	15	40	15	42		80		210	35
8800	321001-0261	40	12	60	12	42		63		70	20

Faltenbälge (Standard-Lieferprogramm)

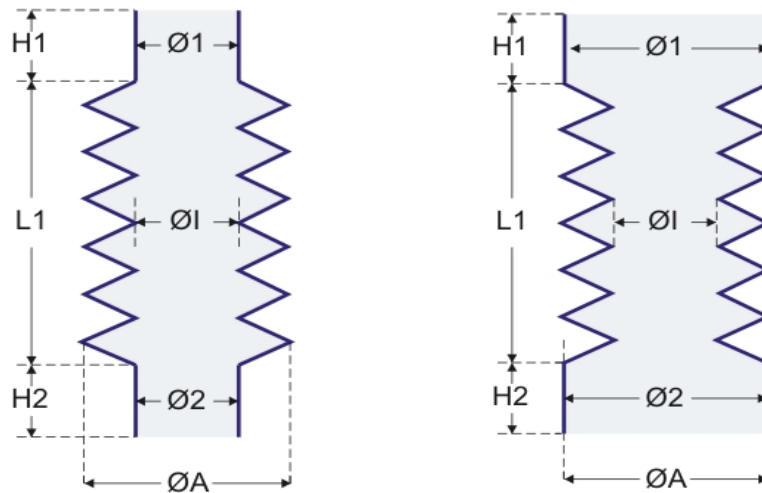

Form-Nr.	Artikel-Nr.	Anschluß-Ø 1 (kleineres Maß)	Anschlußlänge H1	Anschluß-Ø 2 (größeres Maß)	Anschlußlänge H2	Ø1	Ø1-konisch	ØA	ØA-konisch	Länge L1 (gestreckt)	Länge L2 (gestaucht)
10886	321001-0198	40	10	54	10	45		62		140	40
8656	321001-0107	40	12	60	18	45		79		260	60
7292	121001-0983	40	15	62	16	58		85		400	100
5148	324001-0296	40	20	55	20	52		89		400	110
1321	321002-0212	40	15	52	15	45	45	71	78	70	15
5601	321001-0029	40	12	60	18	45		79		230	40
8756	124001-0196	40	11	104	11	83		128		340	60
1241	121001-0737	40	18	40	18	50		65		150	50
7191	121001-0380	40	29	40	29	40		56		230	80
7189	121001-0199	40	29	40	29	40		56		140	45
1102	121001-0179	40	10	40	10	41		71		245	45
1439	321003-0112	41	35	41	35			69		28	
5949	121001-0312	41	13	44	6	48		70		110	55
1045	121001-0674	42	21	55	21	60		96		310	55
1399	121001-0134	42	13	42	13	40		69		300	90
3751	121001-0093	42	15	42	15	50		69		160	50
3628	121002-0076	43		56		52	52	80	94	80	10
2909	121001-1269	43	4	43	4	43		57		40	12
11622	321001-1552	43	14	68	20	70		103		300	70
1429	321001-0215	43	15	43	15	50		83		270	50

Faltenbälge (Standard-Lieferprogramm)

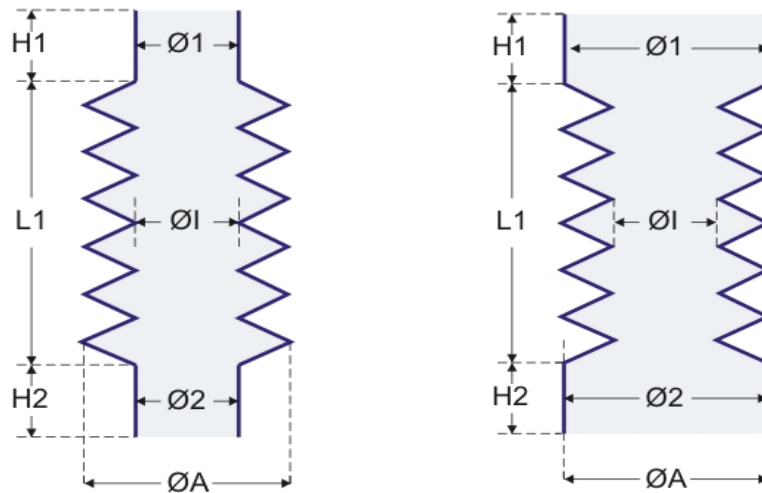

Form-Nr.	Artikel-Nr.	Anschluß-Ø 1 (kleineres Maß)	Anschlußlänge H1	Anschluß-Ø 2 (größeres Maß)	Anschlußlänge H2	Ø1	Ø1-konisch	ØA	ØA-konisch	Länge L1 (gestreckt)	Länge L2 (gestaucht)
5513	121001-0618	43	22	56	22	55		89		200	30
1244	121003-0141	44	35	44	35			70		20	
9791	321001-0090	44	10	44	10	46		62		60	20
2796	324001-0563	44	20	50	20	65		104		350	70
7402	321001-0331	44	10	44	10	46		85		180	30
6141	321001-0050	44	12	50	12	50		80		140	25
5178	121001-0105	45	20	48	20	51		81,5		240	35
8315	324001-0540	45	30	45	30	45		87		650	130
3600	324001-0353	45	22	70	22	48		74		430	120
7203	321001-0925	45	16	67	16	45		101		160	30
2589	324001-0968	45	15	60	15	60		89		600	220
8917	121001-0689	45	10	45	10	48		78		450	75
1447	321001-0442	46	25	58	25	62		87		100	30
11119	321002-0366	47	16	107	18	65		124		60	20
3381	121001-1055	47	12	47	12	51		79		420	100
9274	321001-0751	48	12	48	12	50		82		240	50
1557	321001-0361	48	12	48	12	55		74		60	15
6048	121002-0144	48	18	84	18	56	82	90	119	100	30
1160	121001-0347	48		52		55		76		90	25
6991	324001-0074	49	30	80	30	64		97		370	80

Faltenbälge (Standard-Lieferprogramm)

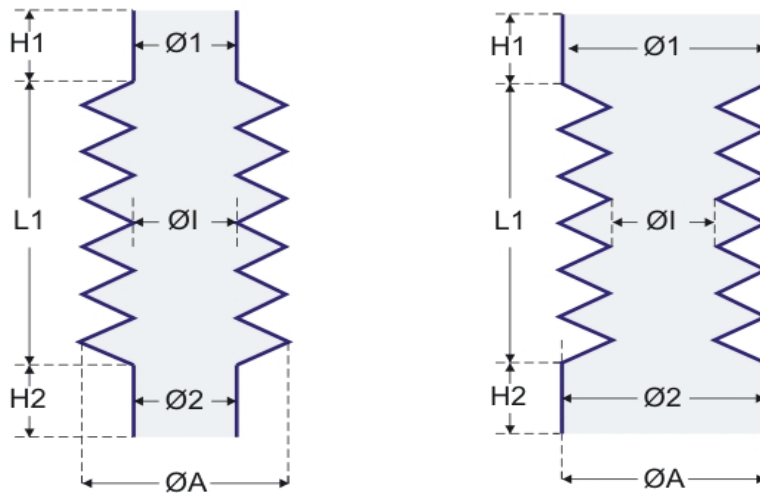

Form-Nr.	Artikel-Nr.	Anschluß-Ø 1 (kleineres Maß)	Anschlußlänge H1	Anschluß-Ø 2 (größeres Maß)	Anschlußlänge H2	Ø1	Ø1-konisch	ØA	ØA-konisch	Länge L1 (gestreckt)	Länge L2 (gestaucht)
8301	124001-0711	50	11	60	16	70		100		340	65
1323	121002-0068	50	18	135	18	60	90	87	152	125	20
6639	121001-0802	50	15	50	15	50		83		370	70
6717	121001-0728	50	15	50	15	42		85		300	40
5500	121001-0023	50	15	50	15	65		89		270	80
7311	324001-0624	50	17	66	17	60		112		650	140
6813	324001-0452	50	23	50	23	54		82		1000	250
6614	324001-0299	50	20	90	20	102		134		320	70
2276	324001-0191	50	20	50	20	60		118		420	90
6781	324001-0176	50	23	50	23	54		82		700	210
7080	321002-0304	50	15	90	15	73	90	102	122	250	45
3523	321001-1326	50	23	50	23	56		72		60	25
6862	321001-0641	50	20	50	20	50		82		160	30
7028	321001-0500	50	15	60	15	50		84		350	80
1405	321003-0072	50	35	50	35			85		30	
5167	321002-0090	50	18	118	15	55	80	80	129	230	45
2918	321002-0015	50	18	86	18	70	70	95	109	70	10
6251	124001-0104	50	15	50	15	50		73		340	90
6848	121002-0376	50	15	90	15	60	90	105	124	320	40
6716	121001-1342	50	15	50	15	42		82		410	60

Faltenbälge (Standard-Lieferprogramm)

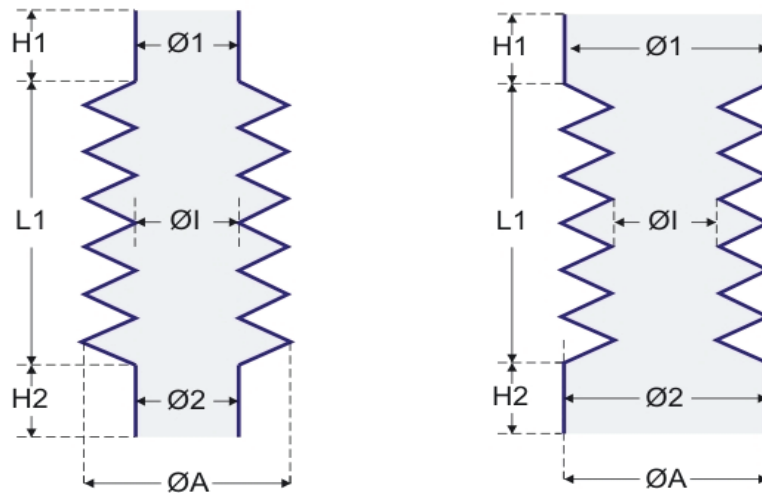

Form-Nr.	Artikel-Nr.	Anschluß-Ø 1 (kleineres Maß)	Anschlußlänge H1	Anschluß-Ø 2 (größeres Maß)	Anschlußlänge H2	Ø1	Ø1-konisch	ØA	ØA-konisch	Länge L1 (gestreckt)	Länge L2 (gestaucht)
6718	121001-0628	50	15	50	15	42		82		270	35
8607	121001-0328	50	8	50	8	45		63		145	45
5738	121001-0038	50	20	50	20	46		63		300	70
6383	121001-0011	50	8	50	8	45		63		120	25
7293	321001-0227	51	16	75	16	58		85		350	110
1024	321001-0096	52	16	56	16	54		84		240	60
6513	321002-0060	52	15	72	10	60	72	85	100	110	30
5170	121001-1131	52	10	52	10	55		89		75	10
1371	121001-1033	53	12	53	10	65		89		120	23
1369	121001-0097	53	15	70	13	50		78		130	30
1687	121001-0740	55	12	74	12	62		84		165	45
5129	121001-0245	55	15	55	15	55		80		110	20
10900	324001-0293	55	15	85	15	86		129		350	70
1514	321003-0232	55	38	55	38			88		26	
3601	321001-0860	55	12	55	12	68		99		130	40
1508	321001-0566	55	18	65	28	65		96		100	20
10884	321001-0447	55	15	75	15	75		108		250	60
5495	321001-0422	55	18	55	18	60		79		60	20
1627	321001-0251	55	12	55	12	58		89		150	30
3902	324001-1887	55	18	55	18	55		98		380	80

Faltenbälge (Standard-Lieferprogramm)

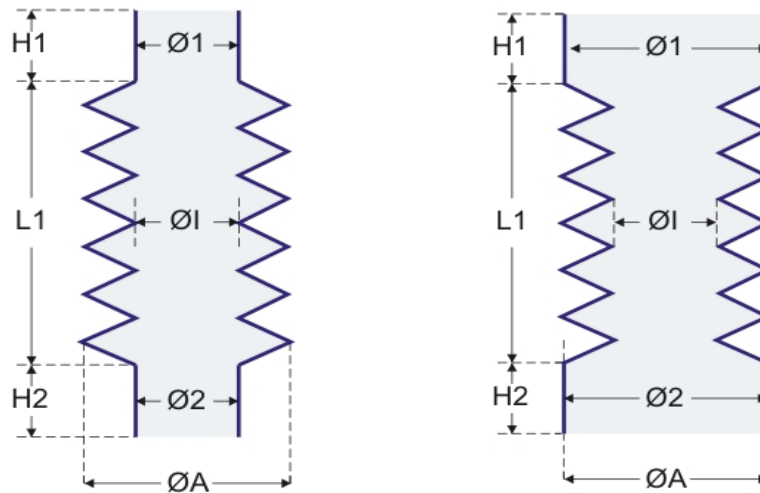

Form-Nr.	Artikel-Nr.	Anschluß-Ø 1 (kleineres Maß)	Anschlußlänge H1	Anschluß-Ø 2 (größeres Maß)	Anschlußlänge H2	Ø1	Ø1-konisch	ØA	ØA-konisch	Länge L1 (gestreckt)	Länge L2 (gestaucht)
5330	124001-0223	55	25	85	16	86		129		480	75
6505	121001-0188	55	17	55	17	55		72		140	30
5209	121001-0650	56	12	59	12	62		89		130	30
1359	321001-0817	57	18	57	18	65		98		150	25
1209	121002-0082	58	12	72	12	70	70	92	102	60	15
5120	324001-0572	58	20	58	20	64		114		700	130
8054	321002-0219	58	16	102	16	72	88	100	130	100	30
1280	321001-0056	58	12	78	12	90		115		140	40
3364	124001-1628	58	20	58	20	45		74		500	110
6720	124001-0381	58	15	70	15	55		89		440	120
8918	124001-0114	59	12	59	12	40		110		420	80
6260	121001-0350	59	15	59	12	60		87		110	30
1320	121001-0912	60	15	75	10	68		98		195	35
5539	121001-0585	60	30	60	50	63		81		90	15
3307	121001-0446	60	18	66	8	66		101		290	55
3633	121001-0316	60		60		64		86,5		130	20
6655	121001-0233	60	15	66	15	66		99		210	30
6676	324001-0466	60	15	60	15	60		96		540	110
2984	324002-0034	60	20	80	20	62	76	100	119	270	50
3396	321001-1069	60	20	60	20	66		99		300	95

Faltenbälge (Standard-Lieferprogramm)

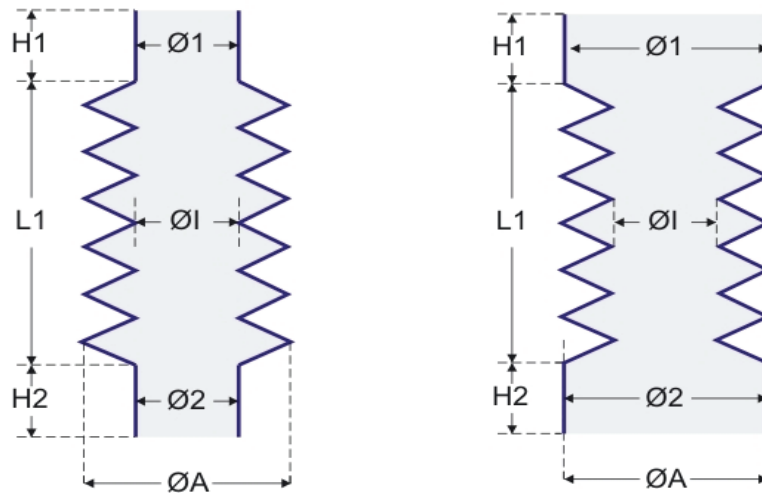

Form-Nr.	Artikel-Nr.	Anschluß-Ø 1 (kleineres Maß)	Anschlußlänge H1	Anschluß-Ø 2 (größeres Maß)	Anschlußlänge H2	Ø1	Ø1-konisch	ØA	ØA-konisch	Länge L1 (gestreckt)	Länge L2 (gestaucht)
1686	321001-0135	60	15	74	15	70		98		150	30
8842	324002-0336	60	20	120	20	65	83	97	119	300	60
6368	324002-0064	60	17	152	15	70	155	97	197	240	40
11230	324001-1377	60	12	88	26	66		93		290	90
1986	324001-1030	60	18	65	18	80		118		500	110
9540	324001-0820	60	20	80	20	66		110		600	140
2486	321001-0851	60	55	60	55	60		94		65	40
2411	321001-0525	60	22	60	22	70		104		100	20
9632	321001-0492	60	15	72	15	70		120		170	30
1142	321001-0444	60	15	60	15	66		100		230	45
6284	321001-0254	60	13	84	15	61		86		210	60
7994	324002-0393	60	18	134	35	78	80	98	124	80	30
1141	324001-0918	60	18	60	18	66		100		450	100
12641	324001-0466	60	15	60	15	60		96		540	140
2333	124002-0051	60	18	140	18	65	145	100	188	365	55
3427	124001-1902	60	18	60	18	62		90		400	90
3589	124001-1036	60	12	60	12	40		79		600	120
8863	124001-0686	60	7	90	15	70		108		420	90
8654	124001-0141	60	12	60	12	43		97		640	100
5112	124001-0120	60	18	60	18	41		74		500	80

Faltenbälge (Standard-Lieferprogramm)

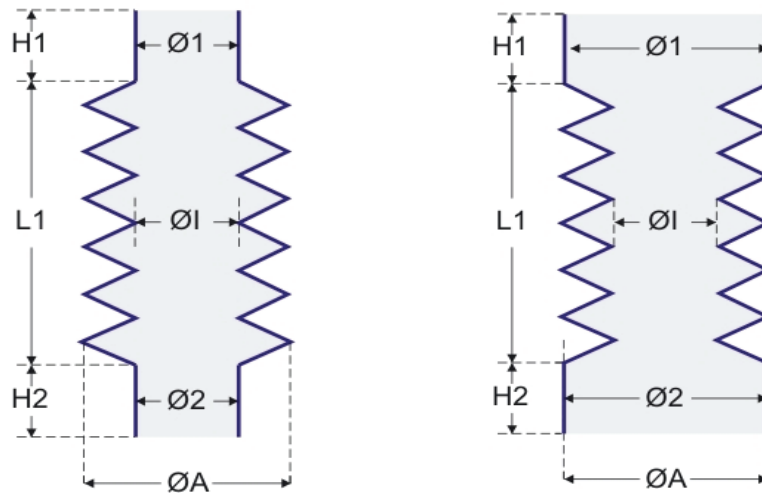

Form-Nr.	Artikel-Nr.	Anschluß-Ø 1 (kleineres Maß)	Anschlußlänge H1	Anschluß-Ø 2 (größeres Maß)	Anschlußlänge H2	ØI	ØI-konisch	ØA	ØA-konisch	Länge L1 (gestreckt)	Länge L2 (gestaucht)
3485	121001-0450	60	28	60	28	62		89		240	70
2894	121001-0099	60	12	90	12	76		119		130	20
3878	324002-0038	62	18	104	18	70	70	92	198	300	70
2296	324001-1094	62	15	84	15	96		128		280	80
6867	321002-0027	62	10	89	10	74	84	91	109	70	30
12109	321001-1186	62	12	62	12	65		115		190	25
6057	321001-0796	63	25	63	25	65		108		120	20
5543	124001-0269	63	12	63	12	60		79		370	100
2536	324001-0798	64	28	64	28	65		94		380	85
7924	324001-0206	64	20	125	20	135		169		270	50
5169	124002-0009	64	18	130	18	72	90	95	154	370	65
1516	321003-0098	65	40	65	40			109		34	
2254	321001-0785	65	18	65	18	74		99		220	60
5996	321001-0741	66	12	76	10	74		98		132	30
9353	121001-0435	66	60	76	20	72		97		260	70
1282	121001-1283	67	14	67	14	70		85		39	9
5193	121001-1041	68	18	68	18	57		81		380	75
1143	124001-0399	68	20	68	20	76		120		320	60
6978	124001-0368	68	15	68	15	45		85		1200	200
2497	121001-0426	68	20	68	20	75		105		140	15

Faltenbälge (Standard-Lieferprogramm)

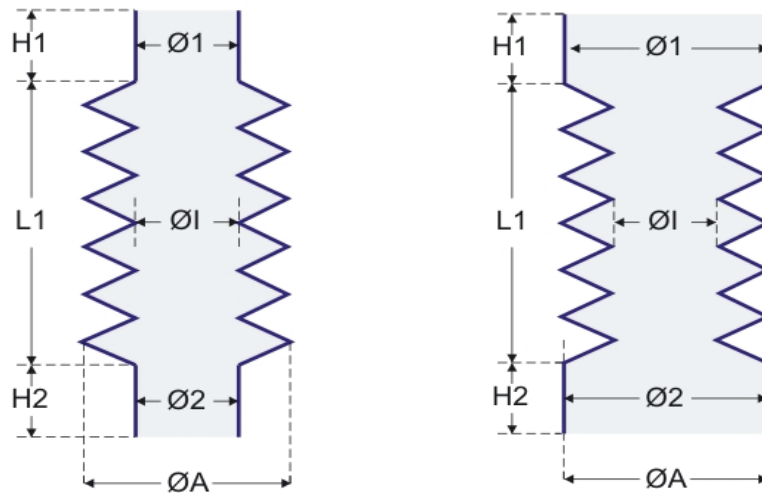

Form-Nr.	Artikel-Nr.	Anschluß-Ø 1 (kleineres Maß)	Anschlußlänge H1	Anschluß-Ø 2 (größeres Maß)	Anschlußlänge H2	Ø1	Ø1-konisch	ØA	ØA-konisch	Länge L1 (gestreckt)	Länge L2 (gestaucht)
1251	321001-1100	68	18	97	23	75		99		150	40
3029	321001-0024	68	20	68	20	74		104		150	30
7071	324002-0067	70	30	100	30	90	110	116	140	250	50
3783	324001-0406	70	40	70	40	87		114		220	60
5121	324001-0297	70	20	70	20	75		109		500	130
1519	321003-0233	70	45	70	45			119		54	
2213	321001-1338	70	15	70	15	80		108		175	40
3474	321001-1040	70	20	70	20	70		89		70	25
1518	121003-0151	70	34	70	34			119		34	
2920	321001-0246	72	12	72	12	80		114		170	35
2309	124001-0661	73	18	93	18	103		141		350	70
5031	324001-0093	73	23	73	23	77		109		380	90
5454	124001-0834	75	30	75	30	66		86		400	131
6190	124001-0135	75	10	75	10	75		110		300	60
3642	324001-0564	75	25	90	25	87		138		630	140
2547	324001-1351	75	30	75	30	78		114		310	60
7029	321001-1090	75	10	75	10	80		100		80	20
1718	321001-0352	75	8	85	8	90		119		90	20
1488	121001-2029	75	23	75	23	90		118		296	65
3264	321001-1406	77	12	77	12	85		119		130	25

Faltenbälge (Standard-Lieferprogramm)

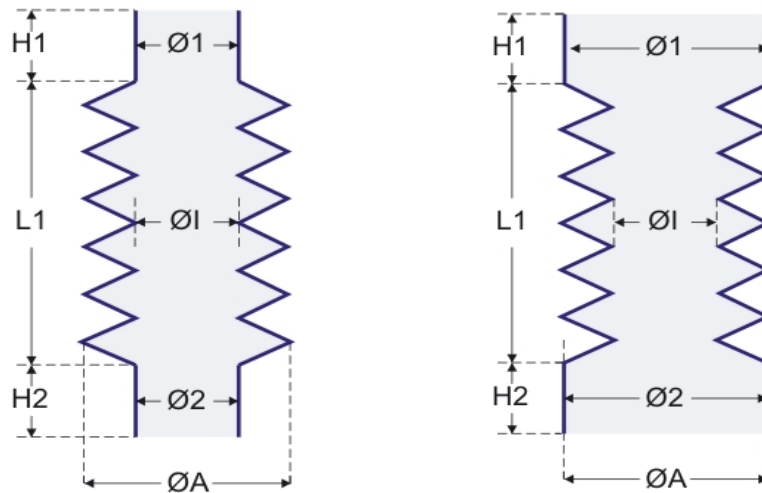

Form-Nr.	Artikel-Nr.	Anschluß-Ø 1 (kleineres Maß)	Anschlußlänge H1	Anschluß-Ø 2 (größeres Maß)	Anschlußlänge H2	Ø1	Ø1-konisch	ØA	ØA-konisch	Länge L1 (gestreckt)	Länge L2 (gestaucht)
2943	121001-1219	78	20	78	20	82		121		270	55
7684	321001-1029	78	12	78	12	84		117		100	20
7761	321001-0826	78	15	130	15	84		116		140	40
1243	321001-0691	78	27	78	27	80		130		250	35
6827	124001-1721	78	10	78	10	86		133		250	25
9603	321001-1260	79	20	79	20	85		116		60	20
6522	124001-0425	80	15	80	15	86		110		220	40
1785	124001-0071	80	22	80	22	65		99		220	45
2113	121001-0522	80	15	80	15	84		115		130	22
8728	324001-0609	80	20	120	30	85		125		330	80
5088	324001-0096	80	18	80	18	84		114		300	90
1520	321003-0191	80	50	80	50			129		57	
3647	324001-0230	80	18	80	18	84		119		550	120
1509	321001-0341	80	15	80	15	85		119		160	30
1509	321001-0341	80	15	80	15	85		119		160	30
2304	124001-1848	80	20	108	20	85		114		180	50
9228	121002-0078	82	15	100	20	88	95	108	122	75	25
1311	324001-0313	83	25	83	25	88		120		300	100
2240	124001-0755	84	15	84	15	90		120		365	80
7909	124001-0680	84	17	119	17	158		230		160	20

Faltenbälge (Standard-Lieferprogramm)

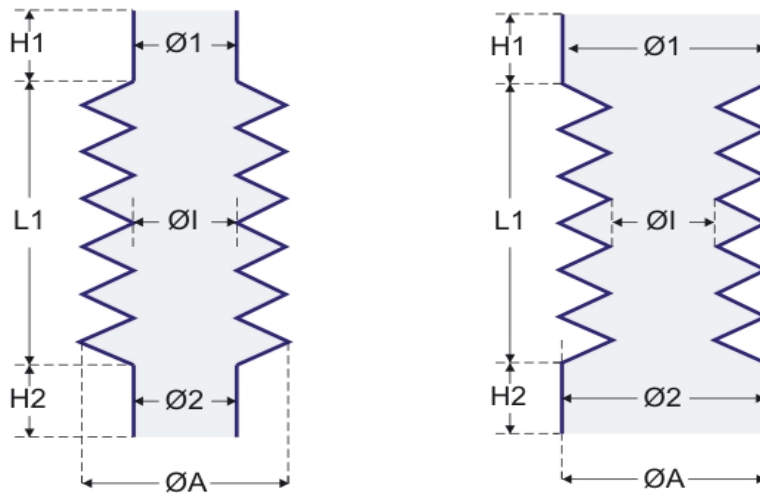

Form-Nr.	Artikel-Nr.	Anschluß-Ø 1 (kleineres Maß)	Anschlußlänge H1	Anschluß-Ø 2 (größeres Maß)	Anschlußlänge H2	Ø1	Ø1-konisch	ØA	ØA-konisch	Länge L1 (gestreckt)	Länge L2 (gestaucht)
3683	324001-0656	84	30	84	30	96		129		100	25
5881	321001-1057	84	25	84	25	86		119		280	50
8082	324002-0157	85	25	180	25	115	170	150	210	180	30
7099	324001-1484	85	50	150	50	150		207		520	130
8934	324001-0868	85	20	85	20	85		117		410	90
6099	124001-1842	86	13	86	13	88		122		190	40
5758	324001-0351	86	12	110	12	110		148		140	20
2228	321001-0908	86	15	105	15	100		128		150	60
1381	324001-1599	88	40	88	40	110		168		260	55
8045	324001-0587	88	11	90	15	90		108		250	90
1199	124001-0670	88	20	130		94		132		400	60
5066	121001-0950	89	25	89	20	89		109		70	15
6804	121001-0170	90	30	100	40	44		94		160	30
6120	324001-0481	90	20	133	20	140		181		460	90
9263	324001-1974	90	12	120	12	96		138		280	50
6058	321001-1227	90	25	90	25	90		134		125	20
5324	324001-0460	90	20	90	20	92		139		420	90
1077	121003-0156	92	38	92	38			151		38	
1706	324001-0347	92	35	92	35	100		138		210	30
3933	321001-1238	94	14	94	14	100		131		100	20

Faltenbälge (Standard-Lieferprogramm)

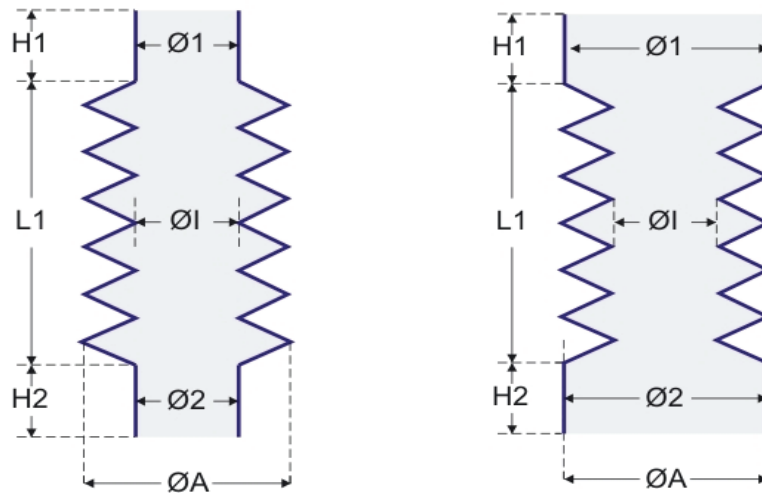

Form-Nr.	Artikel-Nr.	Anschluß-Ø 1 (kleineres Maß)	Anschlußlänge H1	Anschluß-Ø 2 (größeres Maß)	Anschlußlänge H2	Ø1	Ø1-konisch	ØA	ØA-konisch	Länge L1 (gestreckt)	Länge L2 (gestaucht)
1033	121001-0631	95	15	95	15	100		120		80	30
6388	324002-0089	95	12	160	12	105	170	141	206	160	30
2473	324001-0789	95	18	115	18	100		148		250	40
7814	324001-0085	95	15	125	15	112		146		200	50
1778	124001-0824	95	28	95	28	68		136		560	70
7758	124001-0266	95	18	95	18	70		123		930	180
2090	121002-0042	95	15	123	15	100	110	120	148	100	20
5608	121001-0586	95	25	103	4	100		126		50	10
6164	324001-1635	96	30	96	30	103		136		600	160
1242	324001-0961	97	22	97	22	108		142		140	25
1361	324001-0939	97	30	110	30	100		140		240	50
1346	324001-1879	98	50	98	50	103		148		500	75
6826	324001-0094	98	10	98	10	110		152		250	45
5104	124001-0699	98	18	104	18	110		144		150	20
7177	324001-1273	99	20	99	20	116		145		60	20
8171	324001-1139	99	25	124	25	125		178		350	70
2631	124001-0131	100	15	100	15	102		140		220	45
2667	121001-0225	100	25	100	25	100		130		120	30
6485	324003-0116	100	30	100	30			162		60	
11945	324002-0343	100	20	285	20	160	260	210	310	380	40

Faltenbälge (Standard-Lieferprogramm)

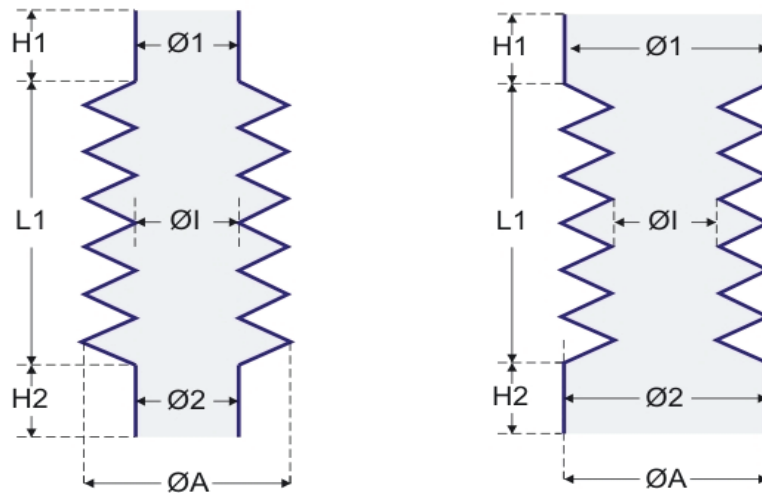

Form-Nr.	Artikel-Nr.	Anschluß-Ø 1 (kleineres Maß)	Anschlußlänge H1	Anschluß-Ø 2 (größeres Maß)	Anschlußlänge H2	Ø1	Ø1-konisch	ØA	ØA-konisch	Länge L1 (gestreckt)	Länge L2 (gestaucht)
6117	324002-0048	100	40	175	40	120	156	165	219	320	45
5793	324001-0367	100	50	100	50	105		154		240	35
5144	324001-0317	100	40	100	40	100		139		70	20
9768	321001-1214	100	10	120	10	110		137		190	70
7618	324001-0569	100	20	140	20	110		158		150	30
1138	124002-0050	100	35	175	35	116	154	165	220	300	60
9320	121003-0034	100	6	100	6			130		30	
2625	121001-0453	100	12	100	12	100		129		155	30
2274	324001-1450	102	23	125	22	130		158		210	70
6231	124001-0382	102	30	102	30	102		134		140	40
2906	121001-1052	104	30	104	30	102		122		150	45
2487	324001-0174	105	40	105	40	118		179		500	90
3873	321001-0468	105	20	105	20	110		148		100	25
9937	124001-0412	105	40	114	50	140		176		400	105
9302	324001-1856	108	14	150	14	165		222		170	20
9246	324001-1757	108	14	150	14	160		222		250	40
3896	324001-0507	108	25	108	25	120		179		350	80
6059	324001-1201	110	25	110	25	110		149		135	25
2793	324001-1612	110	30	110	30	117		148		420	95
6060	321003-0040	110	23	110	23			149		34	

Faltenbälge (Standard-Lieferprogramm)

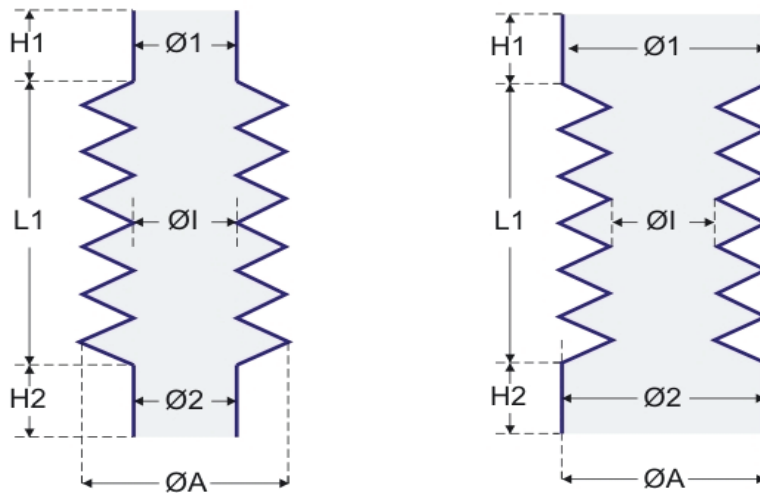

Form-Nr.	Artikel-Nr.	Anschluß-Ø 1 (kleineres Maß)	Anschlußlänge H1	Anschluß-Ø 2 (größeres Maß)	Anschlußlänge H2	Ø1	Ø1-konisch	ØA	ØA-konisch	Länge L1 (gestreckt)	Länge L2 (gestaucht)
2070	321001-0651	115	17	132	15	130		158		100	40
8081	124001-0735	115	30	148	30	145		210		140	25
1093	124003-0109	118	20	118	20			168		40	
2235	124001-0432	120	18	144	15	130		160		110	30
6519	324003-0115	120	20	120	20			180		70	
9544	324002-0339	120	20	318	20	140	272	184	398	250	20
8131	324002-0011	120	12	155	12	128	150	141	189	90	30
3952	324001-0972	120	20	120	20	130		200		250	30
6514	324001-0254	120	20	120	20	125		162		400	90
7436	321001-1360	120	12	120	12	124		142		40	10
1305	124001-0635	120	23	120	20	128		160		215	42
6450	124001-1354	120	12	139	30	145		182		380	80
6268	124001-0754	120	25	120	25	121		148		182	50
8646	324001-0694	124	25	124	25	133		184		150	25
1192	124001-0411	125	20	140	20	140		182		420	90
6088	324003-0054	130	25	130	25			169		30	
2904	324001-0741	130	25	130	25	140		220		380	60
6344	121003-0311	136	20	136	20			195		60	
7973	324001-1921	138	30	138	30	158		190		200	40
3522	324002-0379	140	18	224	18	150	170	180	230	200	50

Faltenbälge (Standard-Lieferprogramm)

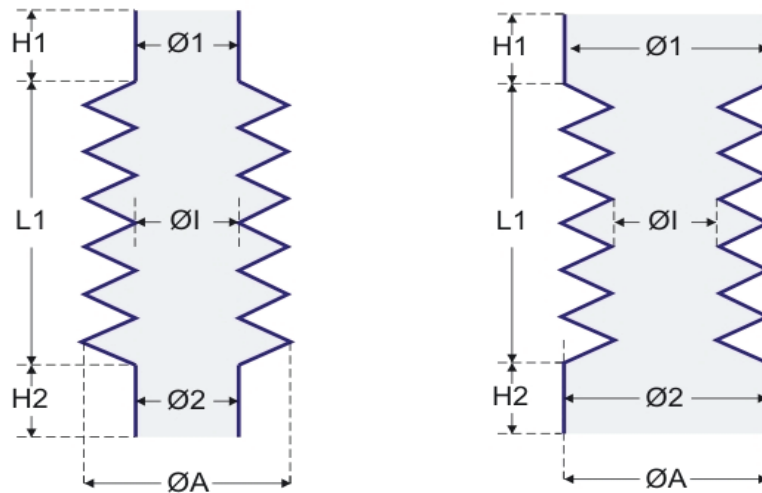

Form-Nr.	Artikel-Nr.	Anschluß-Ø 1 (kleineres Maß)	Anschlußlänge H1	Anschluß-Ø 2 (größeres Maß)	Anschlußlänge H2	Ø1	Ø1-konisch	ØA	ØA-konisch	Länge L1 (gestreckt)	Länge L2 (gestaucht)
3372	324001-1545	140	30	140	30	160		200		340	80
3372	324001-1545	140	30	140	30	160		200		340	80
7325	321001-1322	140	13	140	13	150		176		110	20
2828	321001-1071	140	35	140	35	155		179		90	25
7836	324001-0393	144	20	144	20	172		236		650	100
2395	324002-0131	145	80	200	80	145	190	175	240	180	40
2017	324003-0094	150	35	150	35			225		55	
1325	324001-0881	150	80	150	80	158		214		250	35
8473	324001-0870	150	15	170	15	162		200		210	60
5829	324001-0097	150	18	150	18	156		198		120	20
7667	124001-1110	150	18	150	18	154		203		500	70
3587	321002-0206	155	25	200	25	168	190	190	238	120	25
7429	324001-1701	158	12	158	12	170		197		140	30
6915	324003-0032	160	40	160	40			204		40	
3010	324002-0088	160	16	190	16	168	168	195	216	70	15
3009	324002-0060	160	16	220	16	168	168	195	238	75	15
3011	324001-0275	160	45	160	45	162		190		250	80
2344	321001-0973	160	20	160	20	160		195		100	20
7351	124001-0203	160	15	165	12	165		224		270	50
3431	324001-0231	168	30	168	30	173		210		405	100

Faltenbälge (Standard-Lieferprogramm)

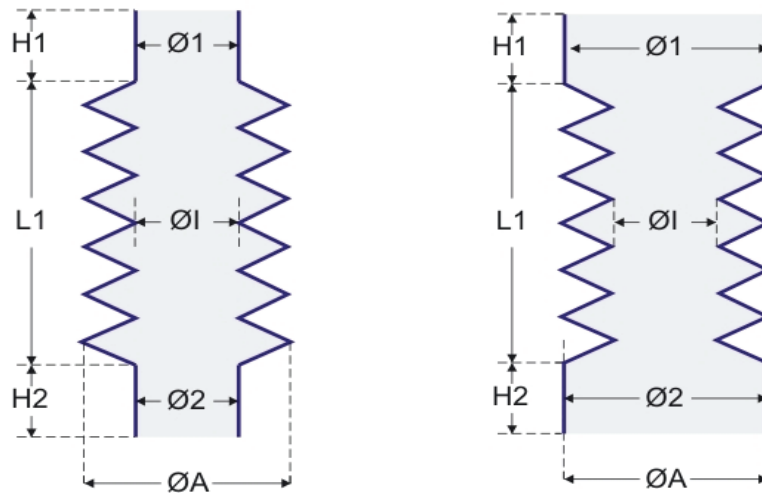

Form-Nr.	Artikel-Nr.	Anschluß-Ø 1 (kleineres Maß)	Anschlußlänge H1	Anschluß-Ø 2 (größeres Maß)	Anschlußlänge H2	Ø1	Ø1-konisch	ØA	ØA-konisch	Länge L1 (gestreckt)	Länge L2 (gestaucht)
8079	124001-0145	170	15	170	15	165		208		250	35
1693	324001-1018	174	27	174	27	190		250		645	90
5836	324002-0029	180	35	300	35	190	270	240	350	280	80
1185	324001-1218	180	12	180	12	185		220		210	50
7274	324001-1113	180	15	200	15	207		238		120	30
5033	324001-0431	180	20	180	20	195		238		120	30
1855	324003-0045	190	55	190	55			240		45	
1085	324001-0474	190	18	190	18	204		235		90	20
7732	324001-0471	190	30	200	30	220		280		330	50
3078	124001-1293	190	11	190	11	190		260		630	120
2668	324001-0478	195	80	195	80	200		240		160	30
6963	324003-0016	200	40	200	40			244		40	
3667	324001-1920	200	50	200	50	200		240		80	20
6109	324001-0267	200	40	200	40	205		258		240	40
7108	124001-0819	200	18	250	30	220		280		270	50
8501	124001-0693	200	30	200	30	200		226		130	35
6912	324002-0236	210	30	340	30	220	340	260	435	250	30
8772	324001-1922	210	35	210	35	273		346		220	25
3895	324001-1165	210	25	210	25	230		300		280	40
2343	124001-0863	210	20	210	20	210		248		120	25

Faltenbälge (Standard-Lieferprogramm)

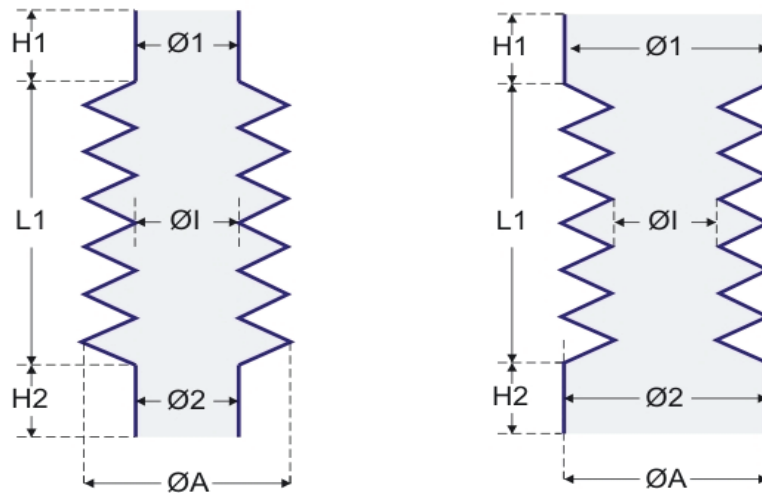

Form-Nr.	Artikel-Nr.	Anschluß-Ø 1 (kleineres Maß)	Anschlußlänge H1	Anschluß-Ø 2 (größeres Maß)	Anschlußlänge H2	Ø1	Ø1-konisch	ØA	ØA-konisch	Länge L1 (gestreckt)	Länge L2 (gestaucht)
3533	324003-0015	215	40	215	40			348		145	
6401	324003-0053	225	20	225	20			254		24	
9801	124003-0028	228	15	234	20			360		64	
1856	324003-0079	240	55	240	55			290		45	
1811	324001-1906	240	25	240	25	250		290		200	45
1091	124003-0132	245	20	245	20			288		45	
8856	324001-0920	254	39	254	39	275		316		80	20
9947	324003-0065	260	20	310	20			365		80	
7166	324003-0031	265	40	265	40			310		44	
5834	324001-0124	265	30	265	30	272		305		140	50
8094	124001-1833	310	45	360	45	335		419		540	65
5725	324001-1344	310	30	310	30	350		395		90	20
5820	324003-0060	320	60	320	60			412		90	
9969	324001-0377	320	25	320	25	330		418		400	50
8651	124001-0165	320	38	320	42	350		392		130	25
3871	324001-0899	360	30	360	30	370		438		150	30
3112	324001-1919	368	40	368	40	380		450		320	65
7628	324003-0086	400	40	400	40			450		37	
7578	324001-1238	410	20	410	20	415		446		110	30

Der Inhalt dieser Druckschrift ist das Ergebnis anwendungstechnischer Erfahrungen. Alle Angaben und Hinweise erfolgen nach bestem Wissen; sie stellen keine Eigenschaftszusicherung dar. Für die Beratung durch diese Druckschrift ist eine Haftung auf Schadenersatz, gleich welcher Art und welchen Rechtsgrundes, ausgeschlossen. Technische Änderungen im Rahmen der Produktentwicklung bleiben vorbehalten. 201011

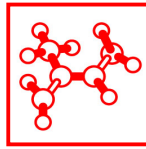
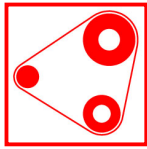

FLUID
ANTRIEB
ELASTOMER
SCHWINGUNG



FAX-Antwort: (0208) 37 83-154

Bitte senden Sie mir mehr Informationen:



Dichtungstechnik
Dichtungen
Stanzeile
Zuschnitte



Antirutschmatten
Kunststoffmatten zur
Ladungssicherung beim
Transport auf Schiene
und Straße



Thermoformteile
Tiefziehteile aus diver-
sen Kunststoffen (ABS,
PS, PP, etc.) hergestellt
im Negativ-Verfahren



Spritzgussteile
Kunststoffteile herge-
stellt im Spritzgussver-
fahren z. B. aus Poly-
urethan



Gummiformteile
gefertigt mit den Verfah-
ren „Compression Moul-
ding“ oder „Transfer
Moulding“



**Kunststoffteile
mechanisch bearbeitet**
Fertigung als Einzel-
serie oder Baugruppen



Faltenbälge
Elastische Schutzteile
für Maschinen, Fahr-
zeuge und Apparate



Latex-Tauchteile
- Membranen
- Kabeltüllen
- Folien
- uvm.



Walzenbeschichtungen
für Prägwalzen, Tauch-
walzen, Kontaktwalzen,
Transportwalzen und
Kaschierwalzen



Polywood® System
Flexible Lagerung von
Coils mit einem innova-
tiven Schienensystem



Polywood® Lagerung
- Coilwedges
- Coilcarrier
- Rollblocks
- Rollcradles



Spaltbandlager
Stand sichere Lagerung
der unterschiedlichsten
Spaltbandabmessungen

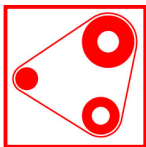

ANTRIEBSTECHNIK
Antriebselemente
Linearsysteme



SCHWINGUNGSTECHNIK
Federungstechnik
Lärmschutz



FLUIDTECHNIK
Hydraulik
Hydraulik-Service

Platz für Ihre Visitenkarte

Einkleben - Kopieren - Faxen

Unsere Anschrift lautet:

Firma: _____

Name: _____

Straße: _____

PLZ / Ort: _____

Telefon: _____

Telefax: _____

E-Mail: _____